

# **FUTURE OF TOKAMAK FACILITIES WITH A BURNING PLASMA EXPERIMENT**

by  
**R.D. Stambaugh**

**Scripps institute of Oceanography  
to National Academies Burning Plasma Assessment Committee**

**January 18, 2003**



008-03/RDS/RS

# DIII-D WILL CONTINUE TO BE A WORLD CLASS PROGRAM AND FACILITY TO CARRY THE U.S. FORWARD TO BURNING PLASMAS

## Physics Measurements

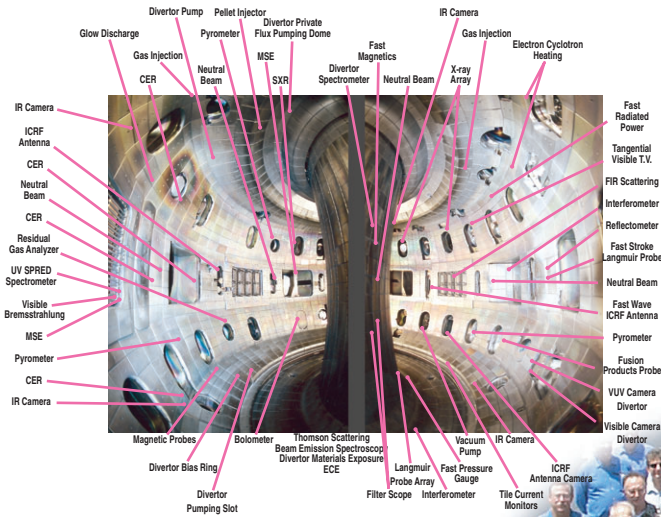

## Flexibility

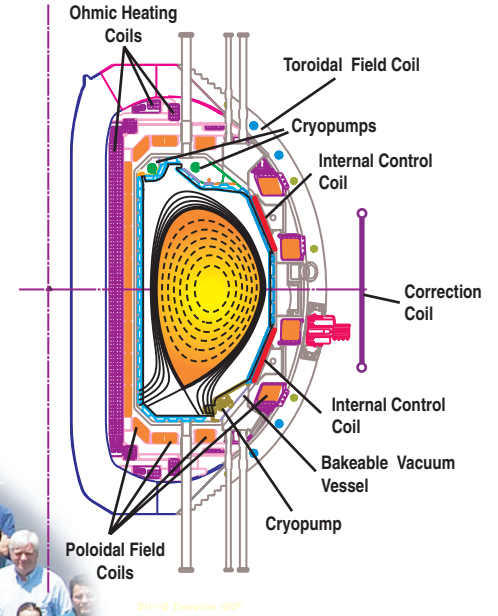

## International Research Team



## Partnerships & Leadership

- Collaborating Exp.
- ITPA
- TTF
- Theory/Modeling
- Burning Plasmas

## Plasma Control

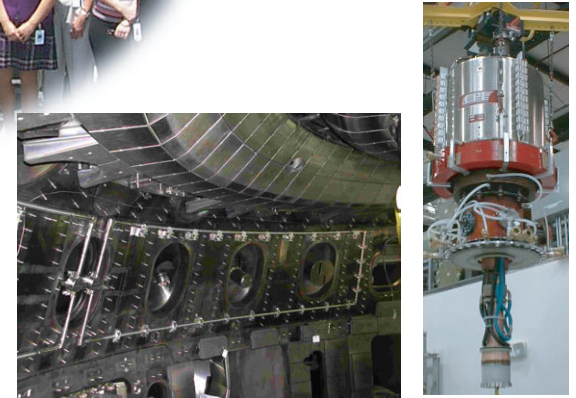

# DIII-D MISSION: ESTABLISH THE SCIENTIFIC BASIS FOR THE OPTIMIZATION OF THE TOKAMAK APPROACH TO FUSION ENERGY PRODUCTION

## ● DIII-D National Program goals

- The DIII-D Program's primary focus is the Advanced Tokamak thrust that seeks to find the ultimate potential of the tokamak as a magnetic confinement system
- Where it has unique capabilities, the DIII-D Program will undertake the resolution of key enabling issues for advancing various magnetic fusion concepts
- The DIII-D Program will advance the science and technology of magnetic confinement on a broad front, utilizing its extensive facility and national team research capability

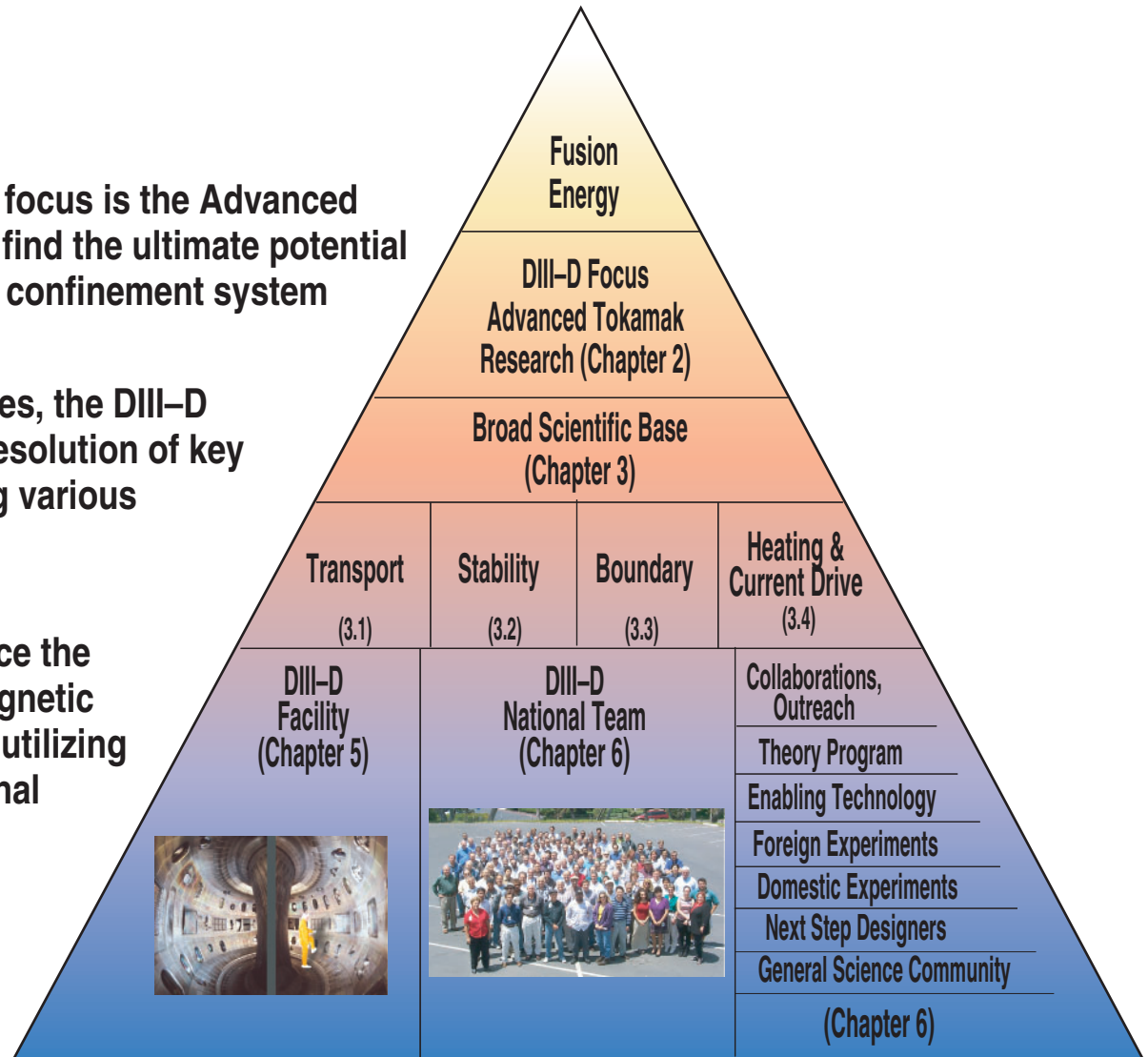

**"The knowledge gained is the program's enduring contribution"**

# THE DIII-D RESEARCH PROGRAM WILL MAKE MAJOR CONTRIBUTIONS IN THREE FOCUS AREAS

---

- **Advanced Tokamak: in-principle steady-state, high performance discharges**
  - Scientific understanding of key elements
    - ★ MHD stabilization
    - ★ Profile optimization
  - Plasma control
  - Integrated self-consistent scenarios
- **Transport: major advance in turbulent transport understanding**
  - Develop state-of-the-art simulations and models
  - Measure turbulence generated flows
  - Measure short wavelength turbulence (electron transport)
- **Burning plasmas: understanding of tritium retention, “mass transport”**
  - Quantify particle sources, sinks and flow channels
    - ★ Measure flows
    - ★ Identify deposition process
  - Measure erosion and redeposition (tritium retention issue)
  - Integrated modeling of the boundary

DIII-D progress over a broad range of science issues will support these accomplishments

# OVERVIEW OF THE DIII-D RESEARCH PLAN

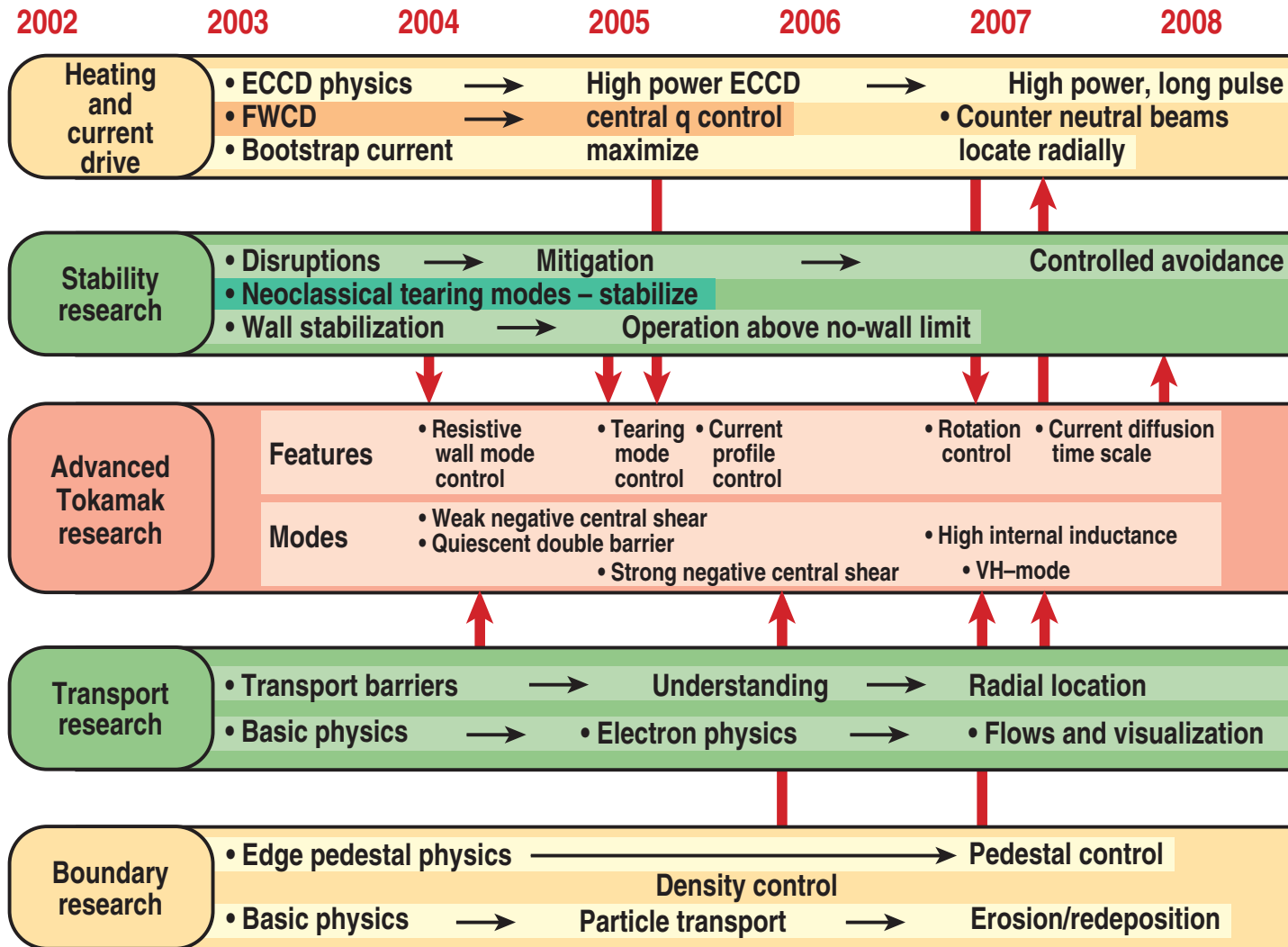

# DIII-D FACILITY CAPABILITIES NEEDED TO MEET ITS MISSION FOR FY04-08

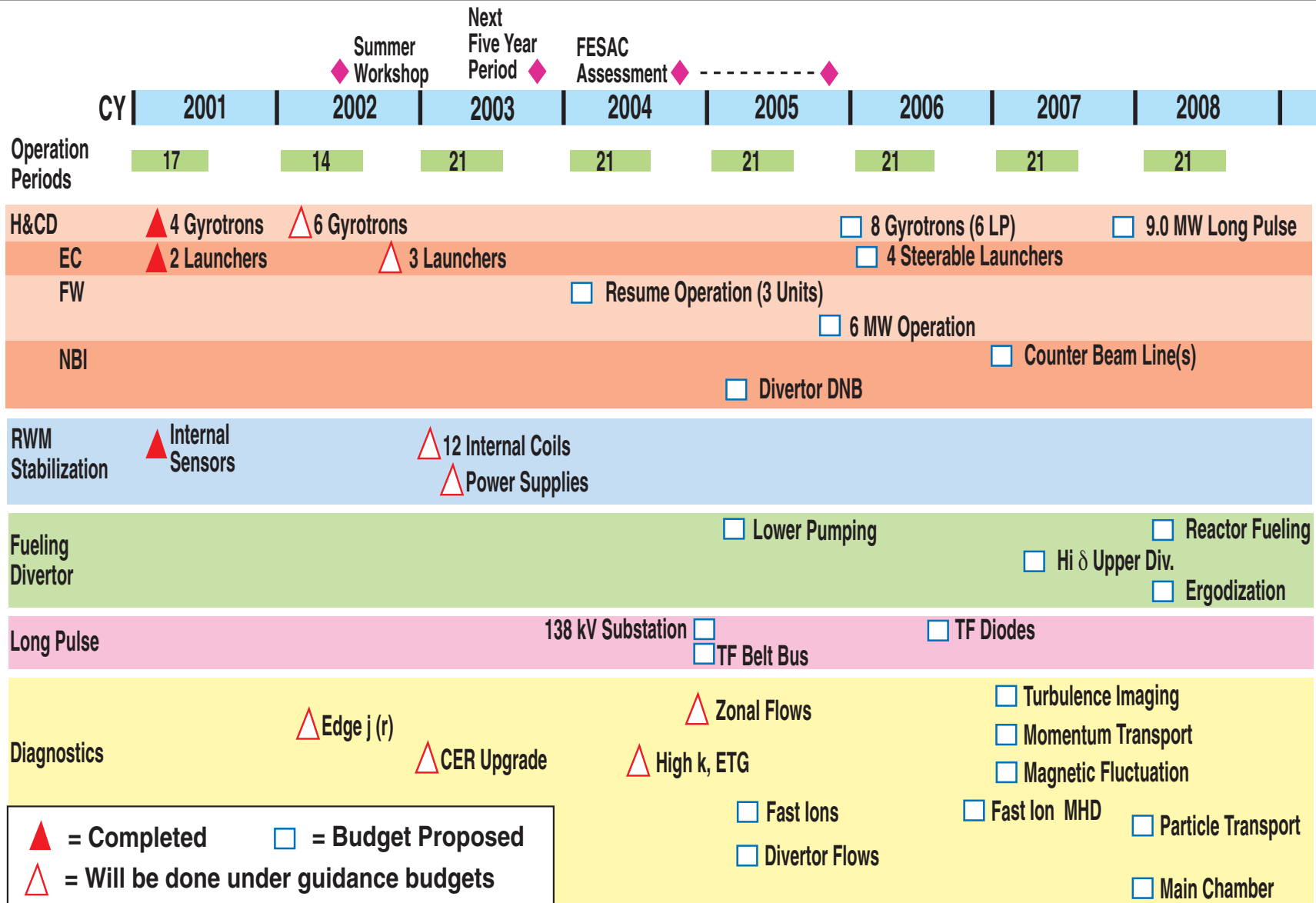

▲ = Completed      □ = Budget Proposed  
 △ = Will be done under guidance budgets



# Alcator C-Mod Program Plans

Address two key programmatic thrusts, and the spectrum of fusion plasma science.

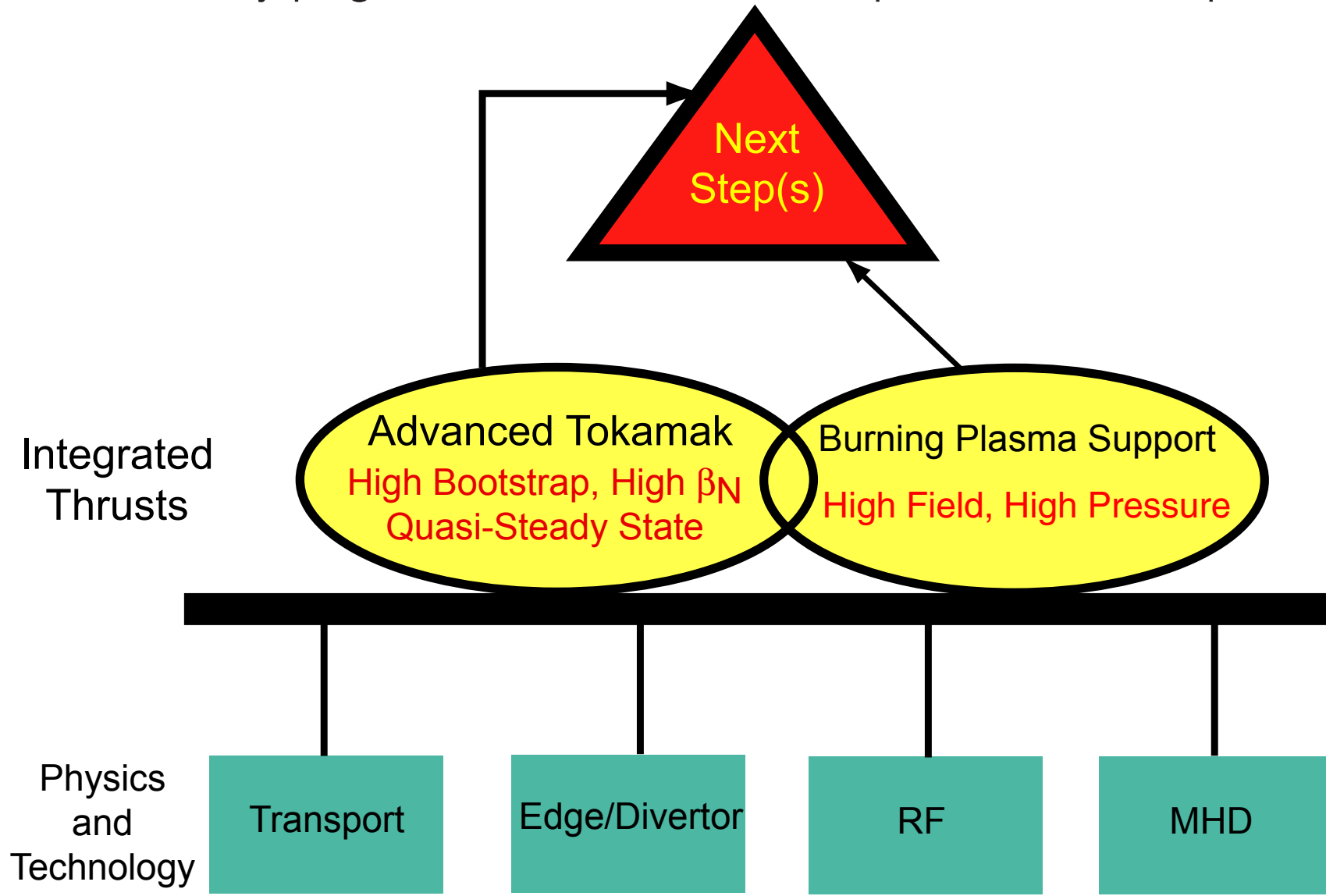

# Unique Features of C-Mod Plasmas

## Address Key Questions



High B (5-8T)  
and  $n_e$  (to  $10^{21} \text{ m}^{-3}$ )

Unique Dimensional Parameters.

key data on similarity/scaling curves  
test sensitivities to non-similar physics

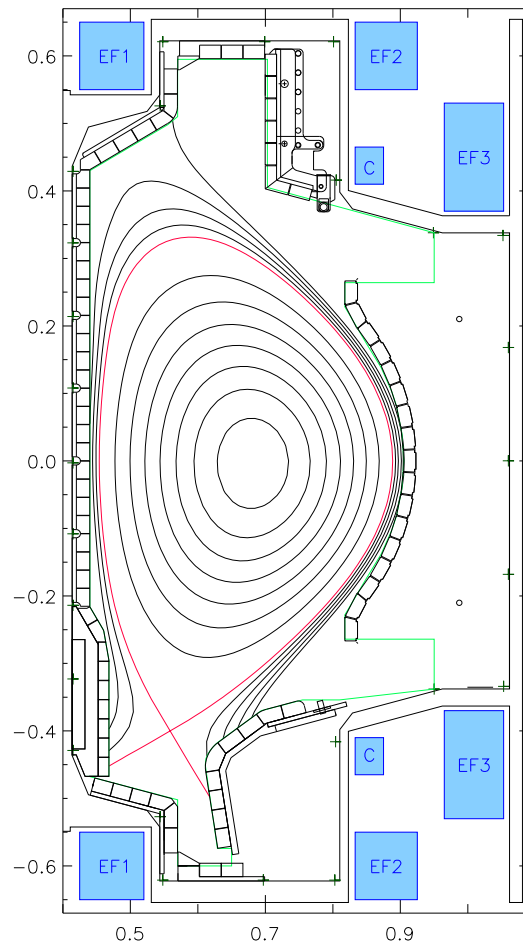

Long pulse length of L/R, current relaxation.

Quasi-steady profile control with Lower Hybrid CD.

High power density, SOL  $\sim 1 \text{ GW/m}^2$ .

unique reactor-prototypical divertor regimes.

High-Z metal first wall.

a reactor requirement; generic MFE challenge.

Exclusively RF driven.

Heating/CD without particle/momentum source

Reactor-relevant ( $T_i \approx T_e$ ) regimes for transport



# C-Mod Topical Physics Program

## Transport:

- Pedestal and ITB mechanisms
- Marginal Stability and Fundamental Mechanisms
- Particle, Electron, and Momentum Transport

## Divertor and Edge Plasma:

- Edge Turbulence and Transport
- Impurity Sources and Transport
- Neutral Dynamics and Fueling
- Power and Particle Handling

## MHD:

- Disruption studies, avoidance, effects, understanding
- MHD control with RF: sawtooth, NTM
- Active MHD Spectroscopy

## RF Heating, Current and Flow Drive:

- ICRF: Absorption, Mode-conversion processes
- LH: Coupling, Current Profile Control, Quasi Steady
- RF Technology and physics in the tokamak environment

# ET-UCLA

## Geometric Parameters:

$R = 5 \text{ m}, B = 0.25 \text{ T}, A = 5 \text{ m}, a = 1 \text{ m}, \kappa = 1.5$

## Future Operating Parameters with ICRF:

$n < 2 \times 10^{13} \text{ cm}^{-3}, T_e < 2 \text{ kV}, T_i < 3 \text{ kV}$

$P_{\text{rf}} < 2 \text{ MW CW}$

$< 10 \text{ MW pulsed}$

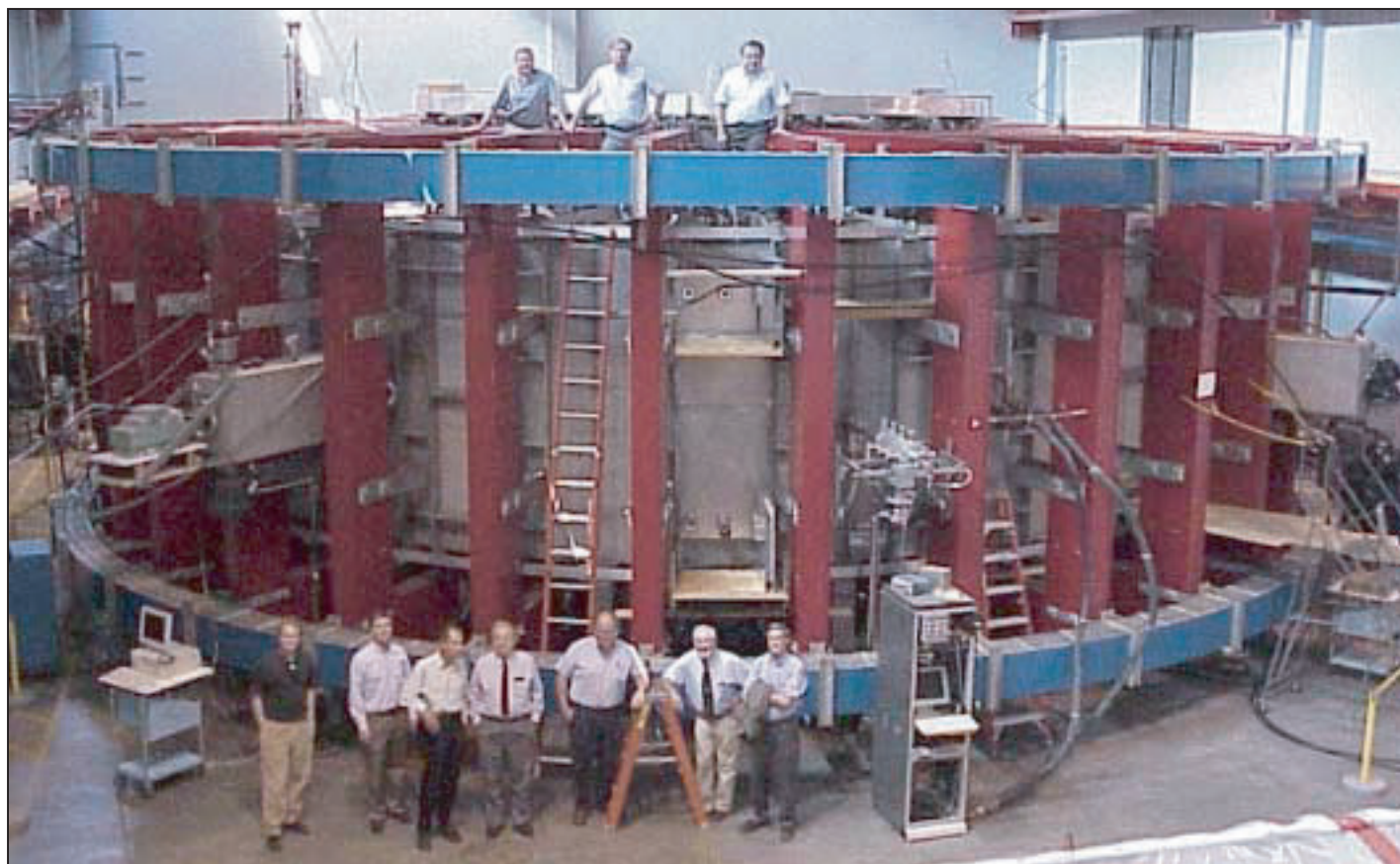



# Targeted Magnetic Configuration

$\psi(R,z)$

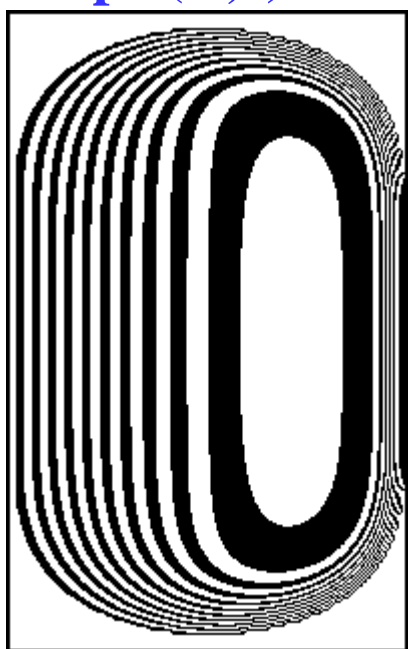

4 m R 6 m

50% average beta configuration

a.u.

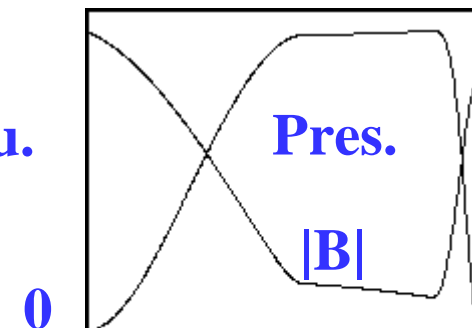

0

3

0

a.u.

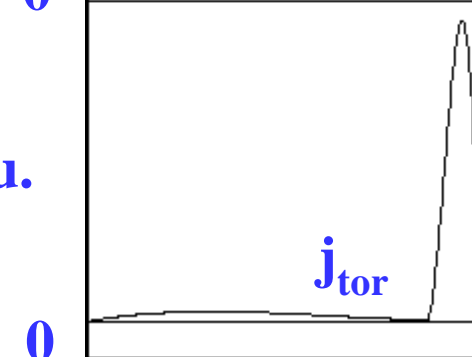

0

4 m R 6 m



# Near term goals

- **Study:**
  - **Poloidal asymmetries**
  - **Electron physics (with LAPD)**
  - **Beta limits**
  - **Disruptions**
- **Expand ICRF to 2 MW**
- **Expand pulse length 10 seconds**
- **Feedback on density and temperature**

# HBT-EP Tokamak Parameters

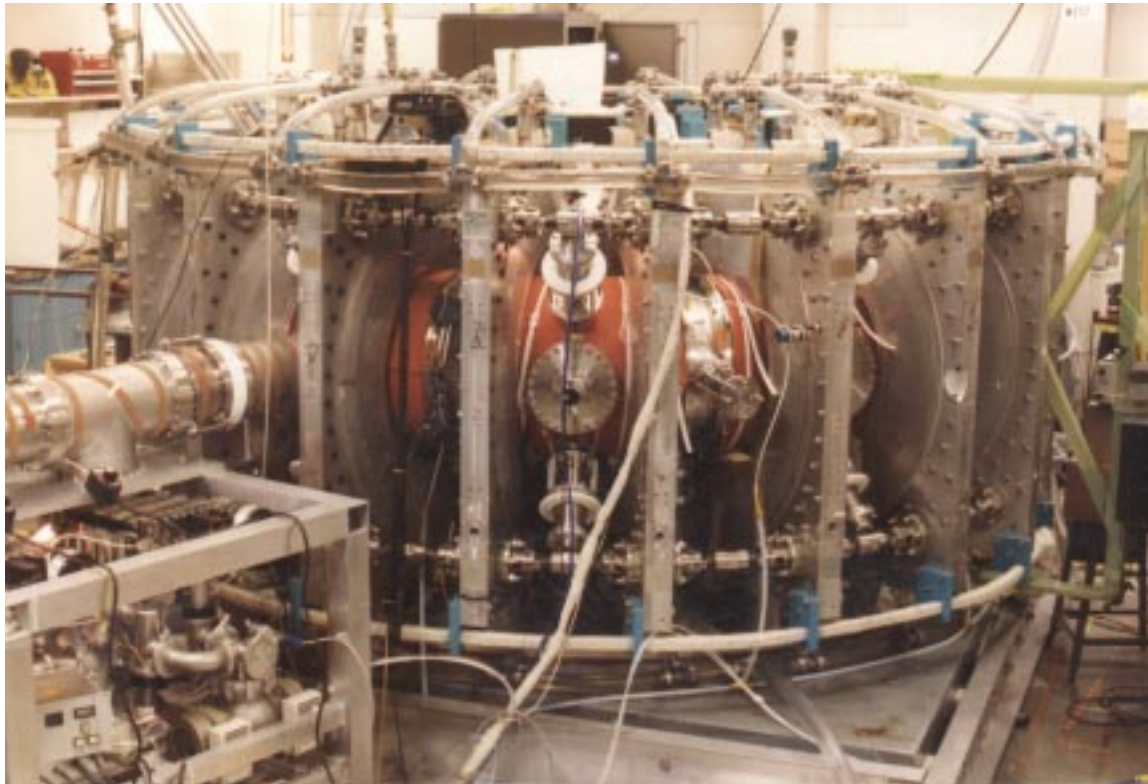

Major radius:  $R_0 = 0.92-0.97$     Minor radius:  $a = 0.15-0.19$  m

Plasma current:  $I_p \leq 25$  kA    Toroidal field:  $B_T \leq 3.3$  kG

Temperature:  $\langle T_e \rangle \sim 80$  eV    Density:  $\langle n_e \rangle \sim 1 \times 10^{19}$  m<sup>-3</sup>

# HBT-EP PROGRAM IN ACTIVE MODE CONTROL

---

- **Passive Control of External Kink Modes with Wall Stabilization**
- **Active Control of Internal Tearing Modes & Magnetic Island Dynamics using Rotating External Magnetic Fields**
- **Active Feedback Control of External Resistive Wall Modes and  $\beta$  Enhancement**



# Smart Shell Active Feedback System with 30 Control Coils Used in the HBT-EP Tokamak to Stabilize the RWM

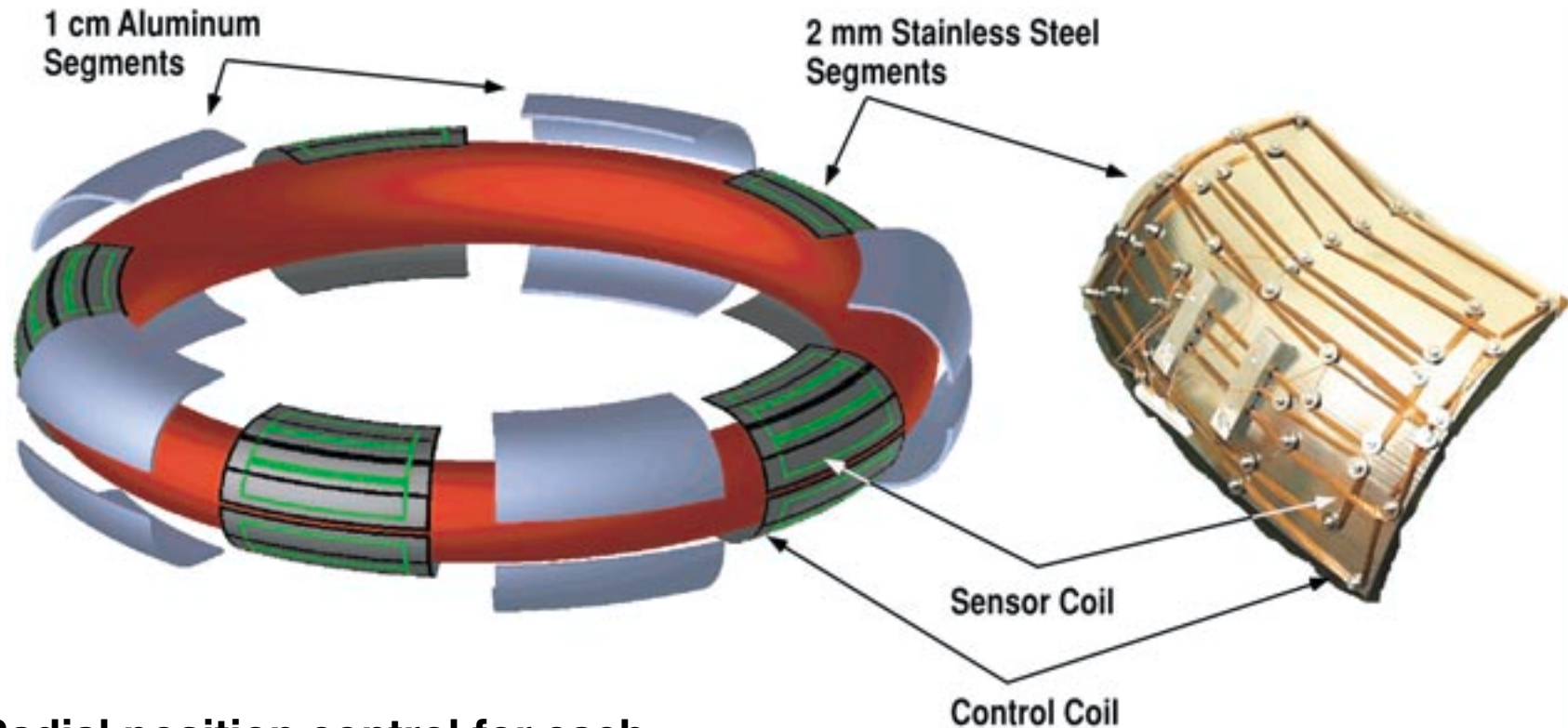

- Radial position control for each aluminum and stainless steel shell segment
- Ideal  $\beta$  limit and effective wall time constant controlled thru radial shell position
- Three control and sensor coils per stainless steel shell segment
- Thirty independent control/sensor pairs for radial flux cancelation

# Adjustable Conducting Wall Position in HBT-EP: External Kink is Stabilized by Nearby Thick Aluminum Wall

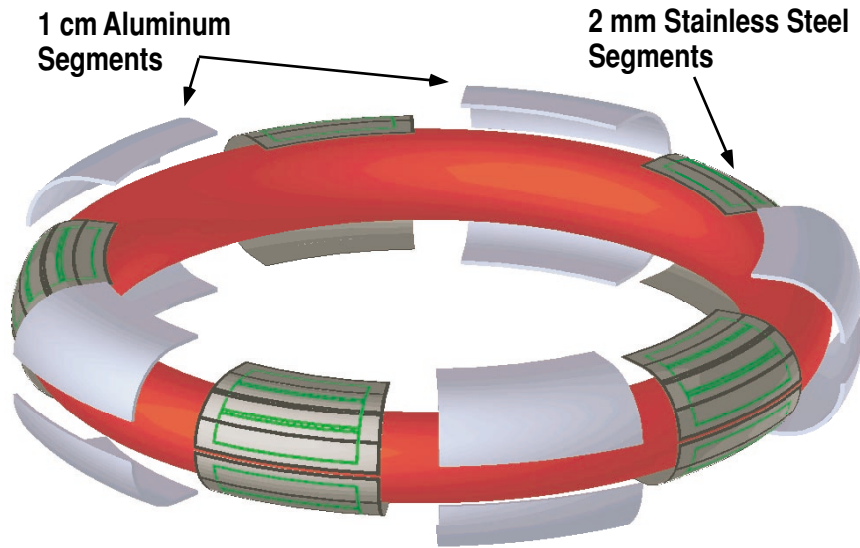

- Radial position control for each aluminum and stainless steel wall segment.
- Ideal  $\beta$  limit and effective wall time constant controlled through radial wall position.

## Wall Retracted

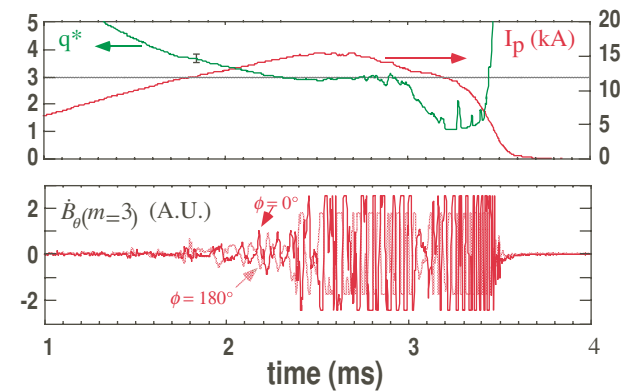

## Wall Near Plasma

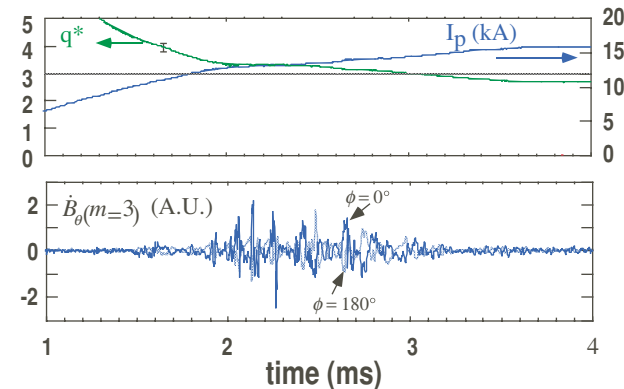

- Use of only 5 thick aluminum wall segments are sufficient to stabilize kink.



# Summary and Plans

---

- **Summary of Results:**

- + RWM Observed With Thin Resistive Wall
- + 30 element “smart-shell” installed and operated in HBT-EP.
- + Demonstration of smart shell active stabilization of the RWM
- + Disruptions at  $q_a < 3$  suppressed with feedback

- **Research Plans:**

- + Test active mode control at the ideal wall stability limit using optimized modular control coil configuration.
- + Study rotation stabilization and rotation-damping effects of the wall stabilized external kink mode (RWM).
- + Extend VALEN to include multi-mode and rotation effects & benchmark these effects in HBT-EP experiments
- + Combine active control of both internal and external modes using a digital control system





# C-Mod and DIII-D Provide Complementary Approaches to Resolving Scientific Issues



	C-Mod	DIII-D
Dimensionless Comparisons (Core and Pedestal)	Compact, Higher Field Larger $\int n dl$	Larger, Lower Field Smaller $\int n dl$
Current Profile Control and Stabilization	LHCD	ECCD
Core Sources of Heat, Momentum and Particles	ICRF, LHRF, MC flow drive	Co/Counter NBI, ECH, FWH
High $\beta$ Stability	Optimize without wall stabilization	Resistive wall mode stabilization
Plasma-Wall Interactions	High-Z metals	Carbon
Disruptions	Toroidal asymmetries High-Z pellet mitigation	Poloidal asymmetries Low-Z gas jet mitigation

# RESEARCH ON CURRENT TOKAMAKS SHOULD CONTINUE UNTIL ITER OPERATES

---

- We must continue to learn and develop the scientific basis for fusion energy. The critical path to fusion power is through learning.
- Some physics issues are better addressed in current machines than in ITER.
- The advanced operating modes which are being developed will be the starting point for research in ITER.
- The research and operating staff for ITER will be trained on current devices.

# THE DIII-D INTERNATIONAL TEAM: THE MOST VALUABLE ASSET OF THE DIII-D PROGRAM

Collaborators are 264 out of 355 users and 60% of scientific FTES



## US Labs

**ANL** (Argonne, IL)  
**INEL** (Idaho Falls, ID)  
**LANL** (Los Alamos, NM)  
**LLNL** (Livermore, CA)  
**ORNL** (Oak Ridge, TN)  
**PNL** (Richland, WA)  
**PPPL** (Princeton, NJ)  
**SNL** (Sandia, NM)

## US Industries

**CompX** (Del Mar, CA)  
**CPI** (Palo Alto, CA)  
**Creare** (Hanover, NH)  
**FAR Tech** (San Diego, CA)  
**HiTech Metallurgical** (San Diego, CA)  
**IR&T** (Santa Monica, CA)  
**Orincon** (San Diego, CA)  
**Surmet** (Burlington, MA)  
**Thermacore** (Lancaster, PA)  
**TSI Research** (Solana Beach, CA)

## US Universities

**Alaska** (Fairbanks, AK)  
**Cal Tech** (Pasadena, CA)  
**Colorado** (Boulder, CO)  
**Columbia** (New York, NY)  
**Georgia Tech** (Atlanta, GA)  
**Hampton** (Hampton, VA)  
**Lehigh** (Bethlehem, PA)  
**Maryland** (College Park, MD)  
**MIT** (Boston, MA)  
**Palomar** (San Marcos, CA)  
**Texas** (Austin, TX)  
**UCB** (Berkeley, CA)  
**UCI** (Irvine, CA)  
**UCLA** (Los Angeles, CA)  
**UCSD** (San Diego, CA)  
**Washington** (Seattle, WA)  
**Wisconsin** (Madison, WI)

## Russia

**Ioffe** (St. Petersburg, Russia)  
**Keldysh** (Udmurtia, Moscow, Russia)  
**Kurchatov** (Moscow, Russia)  
**Moscow State** (Moscow, Russia)  
**Triniti** (Troitsk, Russia)  
**Gycom** (Nizhny Novgorod, Russia)

## European Community

**Cadarache** (St. Paul-lez, Durance, France)  
**Culham** (Culham, Oxfordshire, England)  
**Frascati** (Frascati, Lazio, Italy)  
**FOM** (Utrecht, The Netherlands)  
**IPP** (Garching, Germany)  
**Joint European Torus** (Oxfordshire, England)  
**KFA** (Julich, Germany)  
**Lausanne** (Lausanne, Switzerland)  
**Chalmers U.** (Goteberg, Sweden)  
**Helsinki U.** (Helsinki, Finland)  
**U. Wales** (Wales)

## Japan

**JAERI** (Naka, Ibaraki-ken, Japan)  
**JT-60U**  
**JFT-2M**  
**Tsukuba University** (Tsukuba, Japan)  
**NIFS** (Toki, Gifu-ken, Japan)  
**LHD**

## Other International

**ASIPP** (Hefei, China)  
**KAIST** (Daegon, S. Korea)  
**KBISI** (Daegon, S. Korea)  
**SWIP** (Chengdu, China)  
**U. Alberta** (Alberta, Canada)  
**U. Toronto** (Toronto, Canada)  
**Nat. Nucl. Ctr.** (Kurchatov City, Kazakhstan)

# ALL DIII-D TURBULENCE MEASUREMENTS ARE CARRIED OUT BY UNIVERSITY COLLABORATIONS

- **FIR scattering – UCLA**

- Survey instrument covering entire plasma radius
- Good time and wavenumber resolution

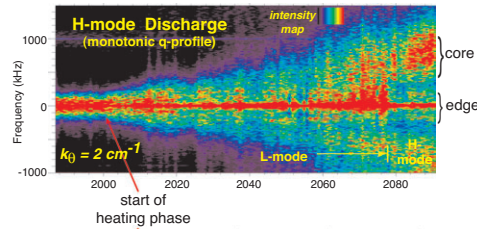

FIR scattering data

L- and H-mode

- **BES (Beam Emission Spectroscopy) – U. Wis.**

- Spatially resolved with ability to provide profiles
- Absolute measurement of turbulence levels

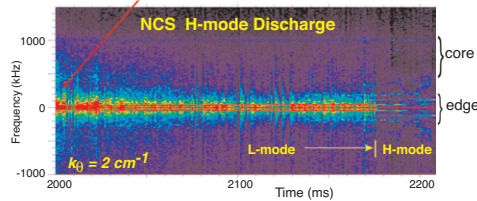

NCS L- and H-mode

- **Reflectometry – UCLA**

- Radial correlation length of the turbulence
- Relative  $\tilde{n}$  with high spatial and temporal resolution

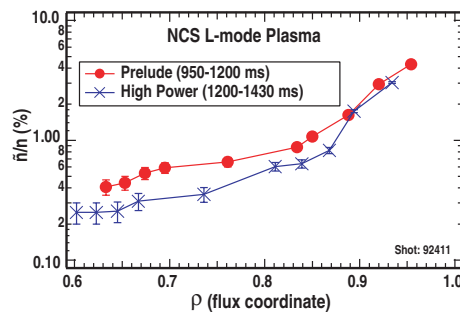

Turbulence level from BES system

- **Phase contrast imaging – MIT**

- Ability to measure long wavelength fluctuations

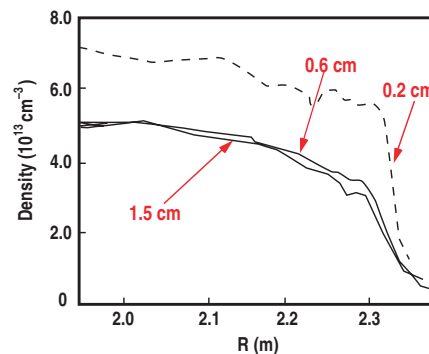

Correlation length from reflectometer

- **Electron cyclotron emission – U. Texas/U. Md.**

- Electron temperature fluctuations

- **Fast edge probes – UCSD**

- Localized edge turbulence

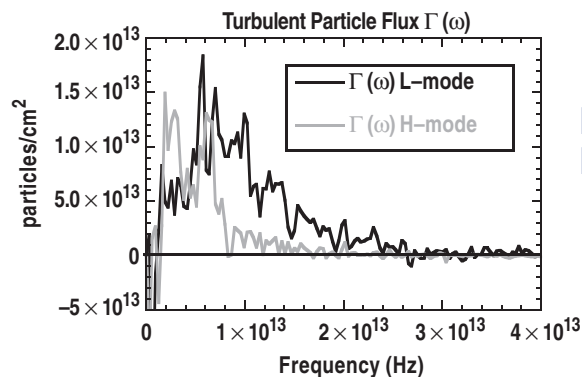

Edge Probe

# Education a Major Alcator Contribution



Personnel funded from the C-Mod budget\*:

Scientific Personnel	Head-Count	
	MIT	Other
Research Scientists	17	12
Faculty	3	1
Postdocs	2	
<b>Graduate Students</b>	20	2

Educating the *next generation of fusion scientists* is very important. Graduate students constitute **about half the scientific effort on C-Mod**. This is the highest fraction [number?] for any one major fusion facility. Alcator graduates about 3-4 fusion plasma students per year. Former MIT students are major players in many fusion programs.

\*(i.e. not including other collaborators; the total facility user/collaborator population is about 160.)

# DIII-D RECEIVED 419 RESEARCH PROPOSALS FOR CY03 FY03, 13 RUN WEEKS ⇒ 35-50 PROPOSALS CAN BE DONE

---

## FOREIGN PROPOSALS

— Frascati	2
— Cadarache	2
— Ipp Germany	6
— JET	18
— Portugal	2
— Spain	2
— Italy	2
— Switzerland	3
— Netherlands	1
— Russia	5
— Japan (NIFS)	1
— <u>Australia</u>	<u>2</u>
<i>Foreign total:</i>	<b>46</b>

## DOMESTIC PROPOSALS BY INSTITUTION

— Columbia	23
— FarTech	3
— GA	165
— Lehigh	3
— LLNL	36
— MIT	6
— ORNL	24
— PPPL	54
— RPI	1
— SNL	5
— UCI	3
— UCLA	13
— UCSD	20
— U. Texas	9
— U. Maryland	1
— U. New Mexico	1
— <u>U. Wisconsin</u>	<u>6</u>
<i>Domestic total:</i>	<b>373</b>

# THERE IS EXTENSIVE INTERNATIONAL COORDINATION OF TOKAMAK RESEARCH

---

## International Tokamak Physics Activity (ITPA)

The ITPA is an international body under the auspices of the IFRC and whose purpose is to coordinate international tokamak research toward a burning plasma experiment

- **Coordinating Committee oversees the work of seven Topical Groups. These groups have leaders and about 3–5 official members from each major party (U.S., E.U., Japan, Russia)**
- **Recent Joint Experiment Planning**
  - In the summer of 2002, leaders of the major tokamak facilities asked the ITPA to prepare a plan for increased joint experiments
  - The ITPA-CC charged the Topical Groups with preparing such plans in their subject areas
  - The Topical Groups in meetings in the fall of 2002 prepared such plans and brought them to the ITPA CC
  - Dr. David Campbell (ITPA-CC chair) presented those plans to the major tokamak program leaders at the IEA Large Tokamak Committee Meeting at MIT in November
  - The leaders agreed on which experiments were likely to get run time on their facilities in 2003 and input these ITPA requests for joint experiments into the various experimental planning processes on the different facilities
  - Expected outcome is significantly increased joint experimental research in 2003



# COOPERATION/COLLABORATION AMONG DIFFERENT EXPERIMENTS PROVIDE INSIGHT/VALIDATION OF PHYSICS

## Planned collaborations

### JT-60U

- Steady-state, high performance
- Divertor/edge

### JET

- Optimized shear/ITB
- NTM
- RF and rotation
- Edge physics

### ASDEX

- NTM
- Counter NBI, ITB

### TCV

- H-mode

### C-MOD

- Pedestal
- SOL
- NTM

### NSTX

- Alfvén
- Transport

### HBT-EP\*

- RWM

## C-Mod/DIII-D Pedestal Similarity

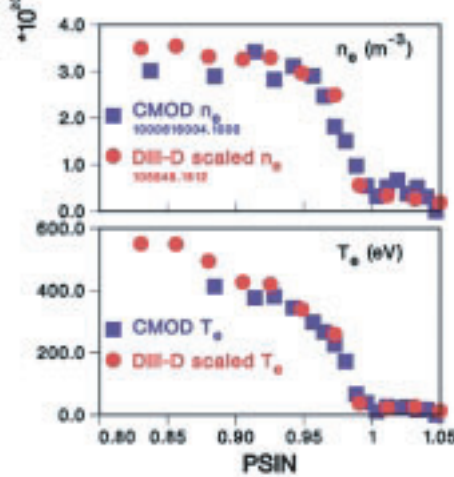

## NSTX/DIII-D Alfvén Instabilities

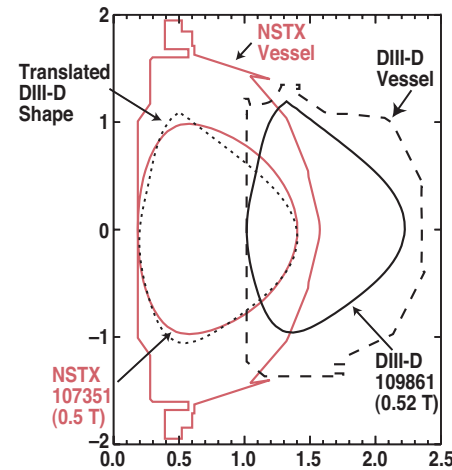

## JET/DIII-D NTM Threshold

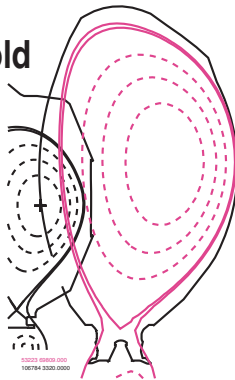

## JT-60U/DIII-D ELM Stability

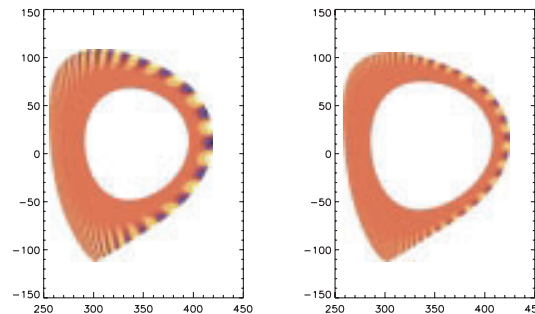

# IMPORTANT SCIENTIFIC CHALLENGES FOR NEXT DECADE

---

- Integration of AT building blocks into scenarios on which to base future machines
- Full exploration and exploitation of the Tokamak's AT potential
- Understanding the basic physics mechanisms of transport from turbulence
- Understanding the H-mode pedestal structure
- Understanding and controlling mass transport in the plasma boundary
- Developing radiative divertors compatible with steady-state AT operation

# RESEARCH STATUS AND ISSUES

Subject	What do we know? Status	What remains to be done?
Stability - Kink Modes	Wall stabilization with rotation works.	Extend to higher $\beta_N$ . Direct feedback with no rotation. Understand rotation physics.
Stability - Tearing Modes	NTM theory still developing. NTM stabilization by ECCD works.	Refine feedback methods - use. Avoid by current profile control. Unify kink-tearing theory?
Disruptions	Successful mitigation technique developed.	Gas jet penetration physics. Plasma control near beta limit.
Confinement	Ion transport understood.	90% of work remains. Understand electron thermal, particle, and momentum transport.
Edge Pedestal Stability	Good theory just developed.	Confirm theory with measurements of edge current densities and pressure gradients.
Edge Localized Modes	Factor two precision in size projection to ITER. Two ELM free regimes found.	Factor 2 projection not good enough. Physics of ELM free regimes unknown.
Edge Pedestal Size	Pressure gradient soon available from above. Pedestal height determines fusion performance with stiff transport models.	Pedestal width physics unknown. Pedestal height is product of width and gradient.
Rotation	Mainly observations.	Understand rotation physics. Big new topic - managing charge?

# RESEARCH STATUS AND ISSUES

---

<b>Neutral Beams</b>	Physics of deposition, heating, and current drive understood. Codes exist.	Co/Counter. Rotation control. QH-mode edge.
<b>Fast Waves</b>	Wave propagation, damping, and current drive understood. Codes exist.	Edge coupling a problem. Only half generator power coupled.
<b>Lower Hybrid Waves</b>	Wave propagation, damping, and current drive understood. Codes exist.	Can we couple to AT plasmas? Antenna needs to touch plasma.
<b>Electron Cyclotron Waves</b>	Propagation and damping understood. Physics basis of current drive recent accomplishment. Codes exist.	Current profile control with high power source.
<b>Current Drive</b>	Basics of NBCD, LHCD, FWCD, and ECCD understood.	Need an efficiency breakthrough.
<b>Bootstrap Current</b>	80% bootstrap current at low performance achieved.	High bootstrap fraction at high performance - central AT goal.
<b>Current Profile Control</b>	Directions from theory clear - broaden.	Experiments just starting.

# RESEARCH STATUS AND ISSUES

---

Power exhaust	High density dissipative divertor solution. Predictive codes - some extensions needed.	"Low" density solution for steady-state plasmas. Apply codes.
Erosion, Flows, Redeposition	Ideas and basic concepts emerging.	Code improvements and diagnostics needed. Key issues are radiative divertor in steady-state and Tritium retention in the machine.
AT scenarios	Building blocks nearly in place. Need higher power EC on DIII-D and LH on Alcator C-mod.	$\beta_N = 4$ and $H_{89P} \sim 2.5 - 3$ in 4–6 years if sufficient support. Need to integrate current profile control, stabilization of kinks and tearing, transport barrier control, and low density divertor. Ultimate potential $\beta_N = 5$ and $H_{89P} \sim 3.5$ takes longer.
Transport barriers	Sheared ExB flow mechanism established. Shafranov shift currently investigated.	Need to locate a gentle barrier in outer 1/3 of plasma radius. How?

# THE NUMBER OF AT REGIMES IS GROWING, NOT CONTRACTING

AT Regime	Advantages	Issues
High bootstrap fraction weak shear	Least tearing trouble Long-pulse AT mode for ITER?	Steady-state current profiles – Getting high bootstrap fraction – Current drive Lower ultimate $\beta_N$
QH/QDB regimes	No ELMs! Possibility of steady-state Double barriers separated by $\omega_{E \times B}$ zero crossing	Peaked density profiles – Core impurity accumulation, narrow bootstrap profile, reduced stability limits – $\omega_{E \times B}$ zero crossing limits core barrier expansion Counter NBI requirement? – Balanced NBI may be just as good
Strong negative central shear ("current hole" is extreme case)	Stable microturbulence Potentially highest $\beta_N$	Obtaining large $q_{min}$ and ITB radii Wall stabilization Off-axis current drive
VH-mode	Transport barrier just in the right place for ultimate AT	Terminations by large ELM Particle (main and impurity ions) accumulation inside ELM-free edge
High internal inductance	Good $\beta_N$ without wall stabilization	Limited bootstrap fraction
RI mode	Consistent with high $\ell_i$	Increase $Z_{eff}$



- ***The best features of each AT regime may be combined to form new regimes.***

# WALL STABILIZATION LOOKS LIKE IT WILL WORK MAJOR BREAKTHROUGH IN 2001

- Spinning plasma improves prospects for fusion energy
  - Washington Post, Physics Today, New Scientist, San Diego Union Tribune

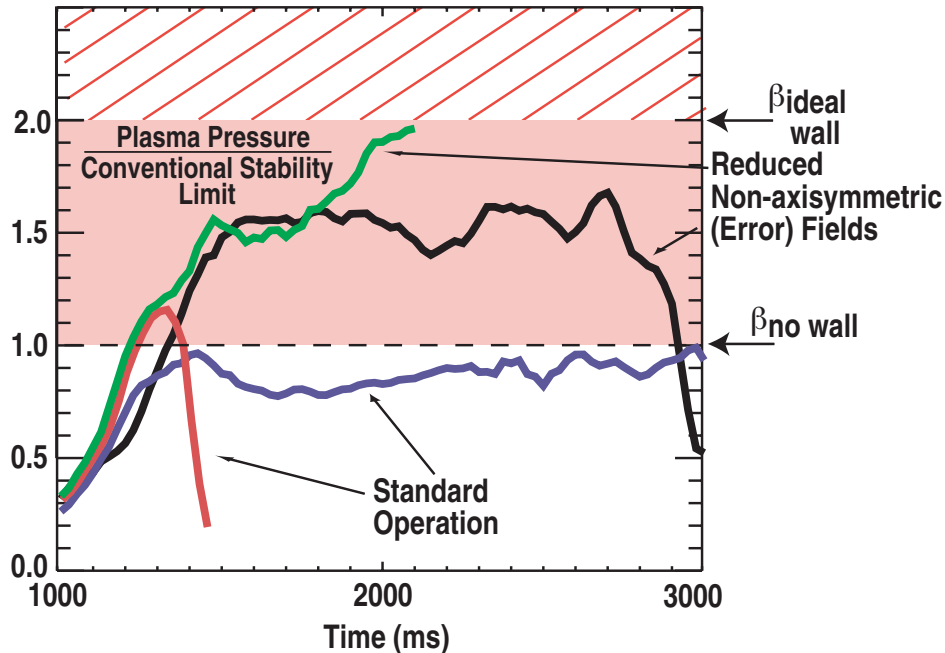

- $\beta_N > \beta_N^{\text{no wall}}$
- $\beta_N \sim \beta_N^{\text{ideal wall}}$

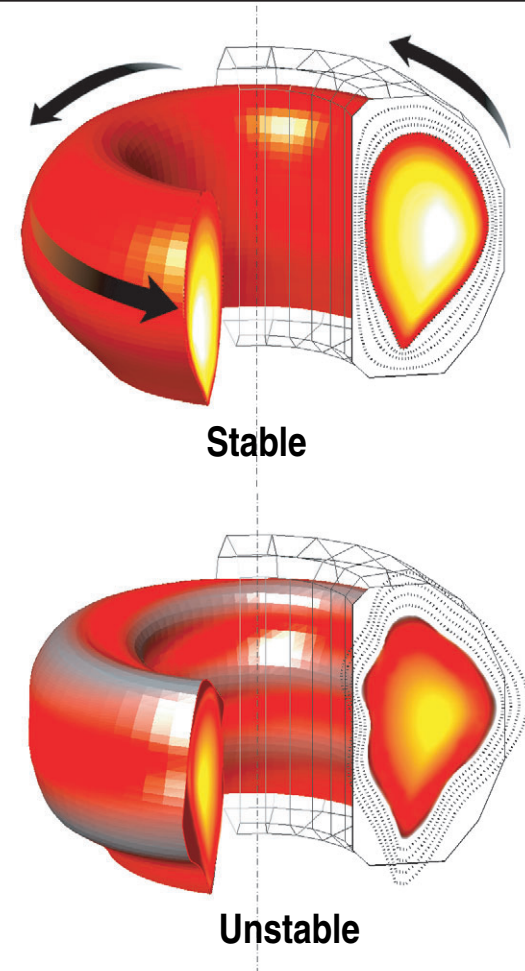

- U.S. has uncontested world leadership in this research

# RESISTIVE WALL MODE MITIGATION ALREADY ALLOWS OPERATION ABOVE NO-WALL LIMIT AT HIGH $\beta_N$

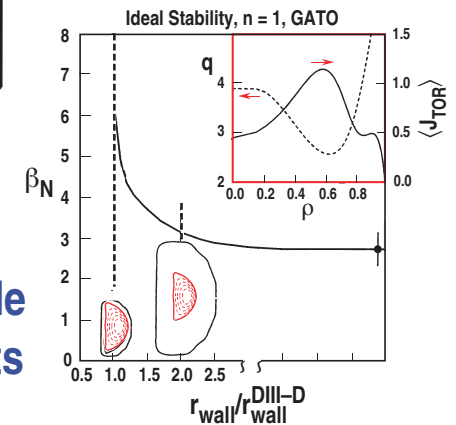
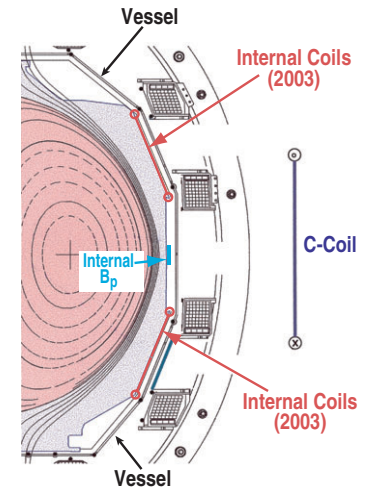
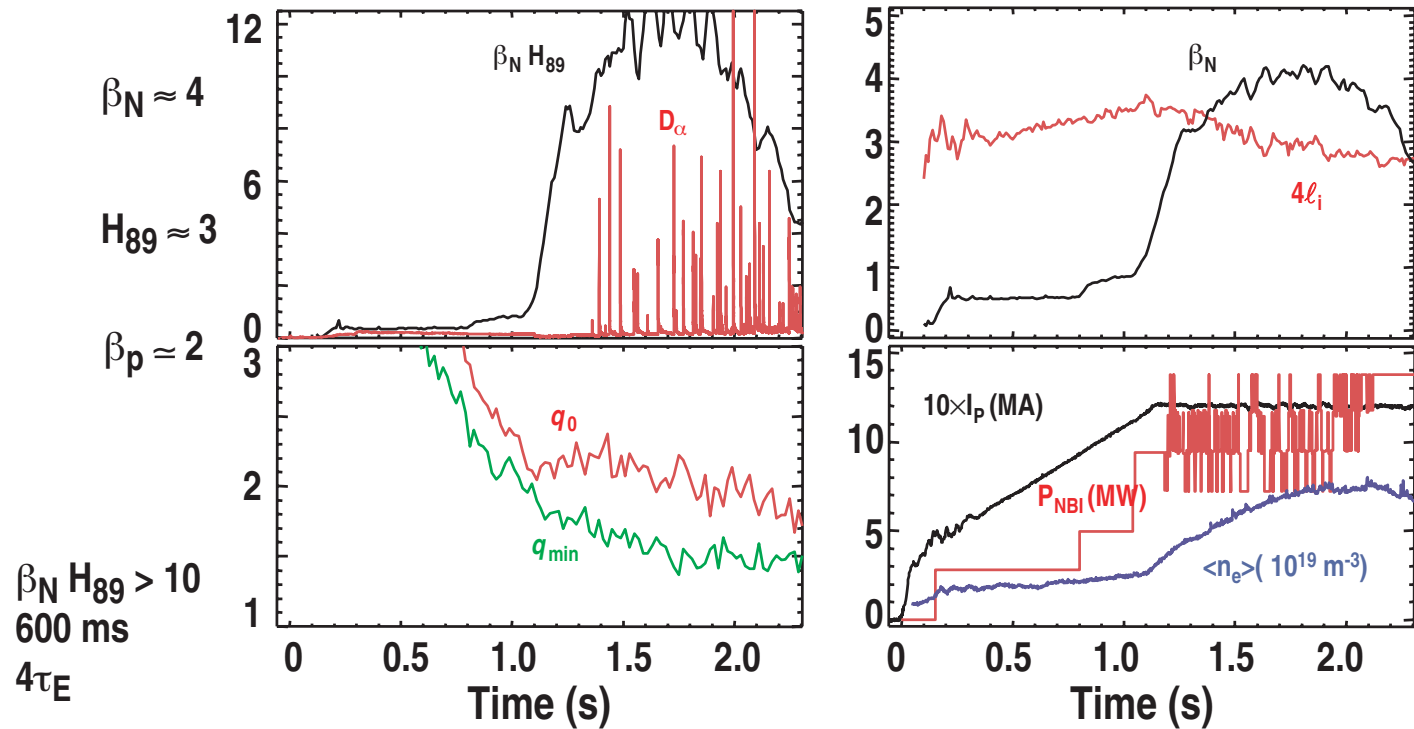

- Achieved through rotational stabilization of resistive wall mode
- Technique now in routine use during high beta AT experiments
- Duration and  $\beta$  limited by tearing mode as  $q$  profile evolves



# Angular momentum transport without internal momentum sources

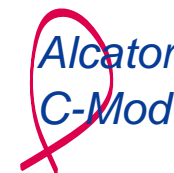

### Density Profile Evolution

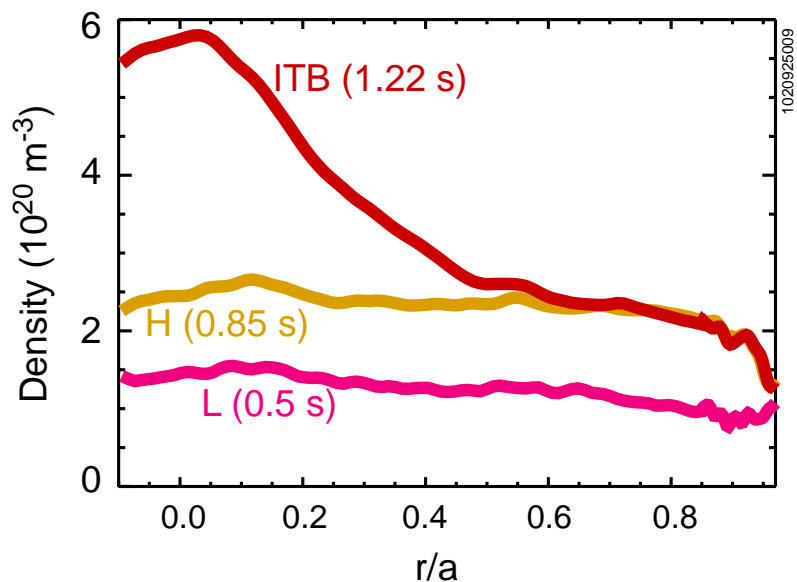

- At L to H transition, rotation appears first off-axis, then diffuses inward
  - Momentum transport time comparable to energy
- As ITB develops, rotation slows inside barrier first, outside later

### Toroidal Rotation Profile Evolution

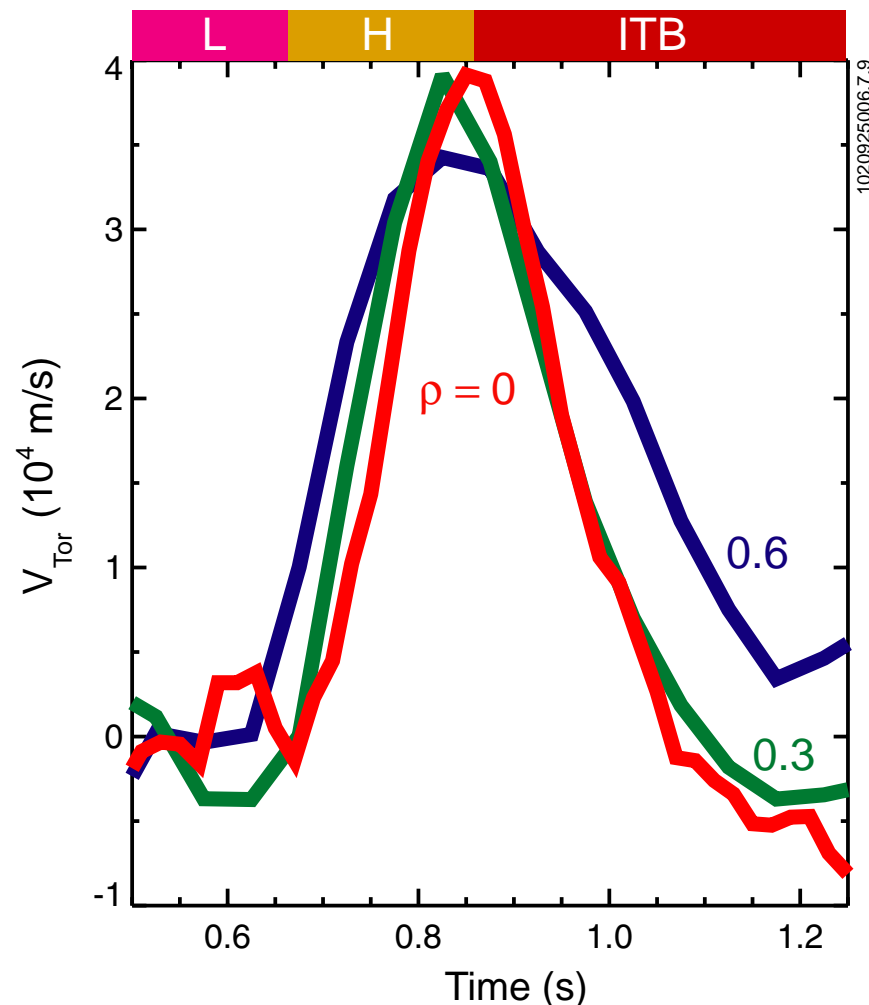

# 2/1 NEOCLASSICAL TEARING MODE STABILIZATION REQUIRES 6 GYROTRONS FOR >5 SECONDS

Success

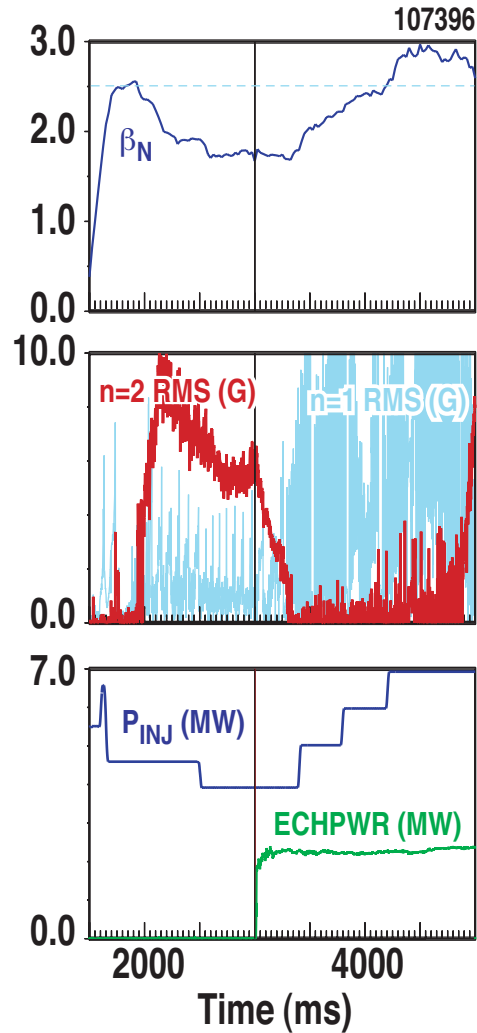

Challenge

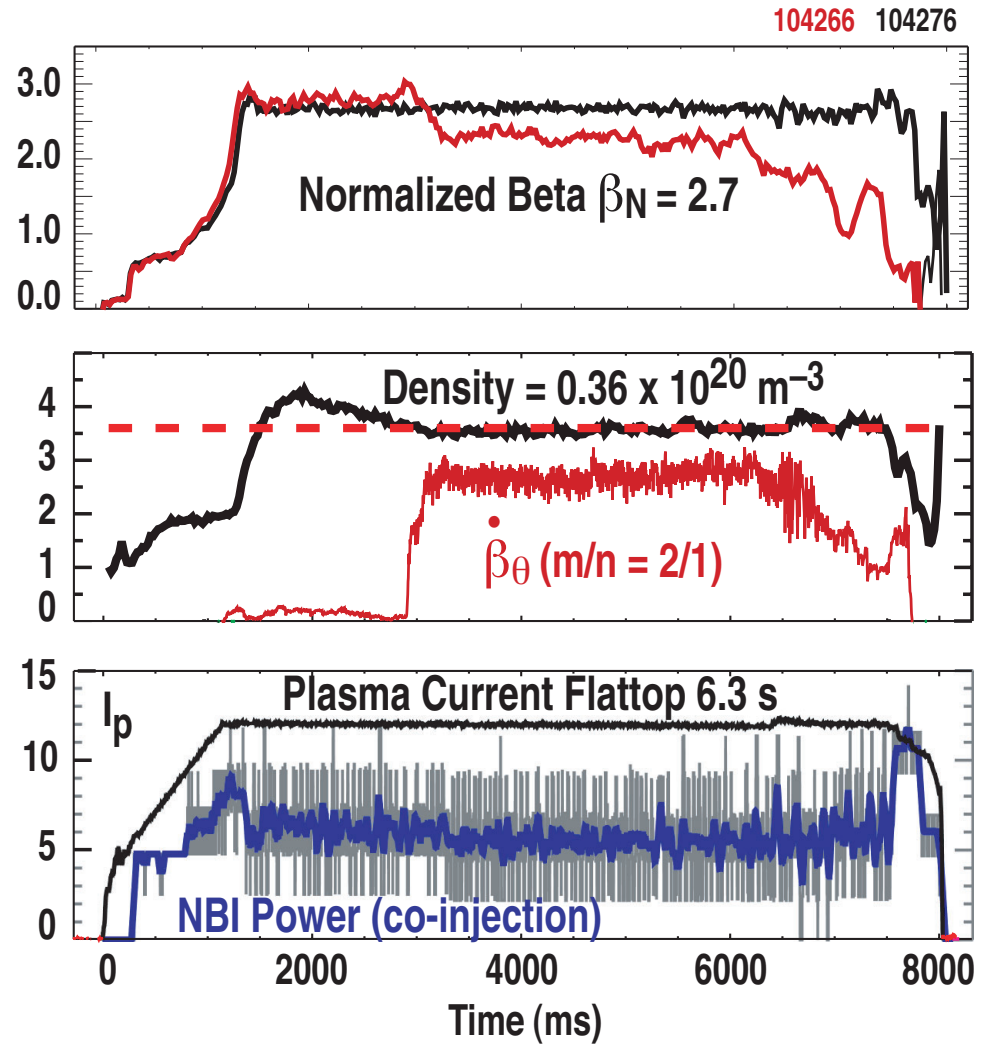

# A SIMPLE AND ROBUST METHOD OF MITIGATING THE EFFECTS OF DISRUPTIONS HAS BEEN DEVELOPED

- High pressure gas jet penetrates to center of core plasma
- Centrally deposited radiating impurity provides optimal thermal and halo current mitigation
  - 99% Radiated
  - Halo currents  $\leq 10\%$  of  $I_p$
- A sufficient quantity of injected gas suppresses runaway electrons by collision damping on neutrals
- Physical models of mitigation have been developed and validated on DIII-D, giving confidence in our extrapolation of this technique to burning plasma experiments

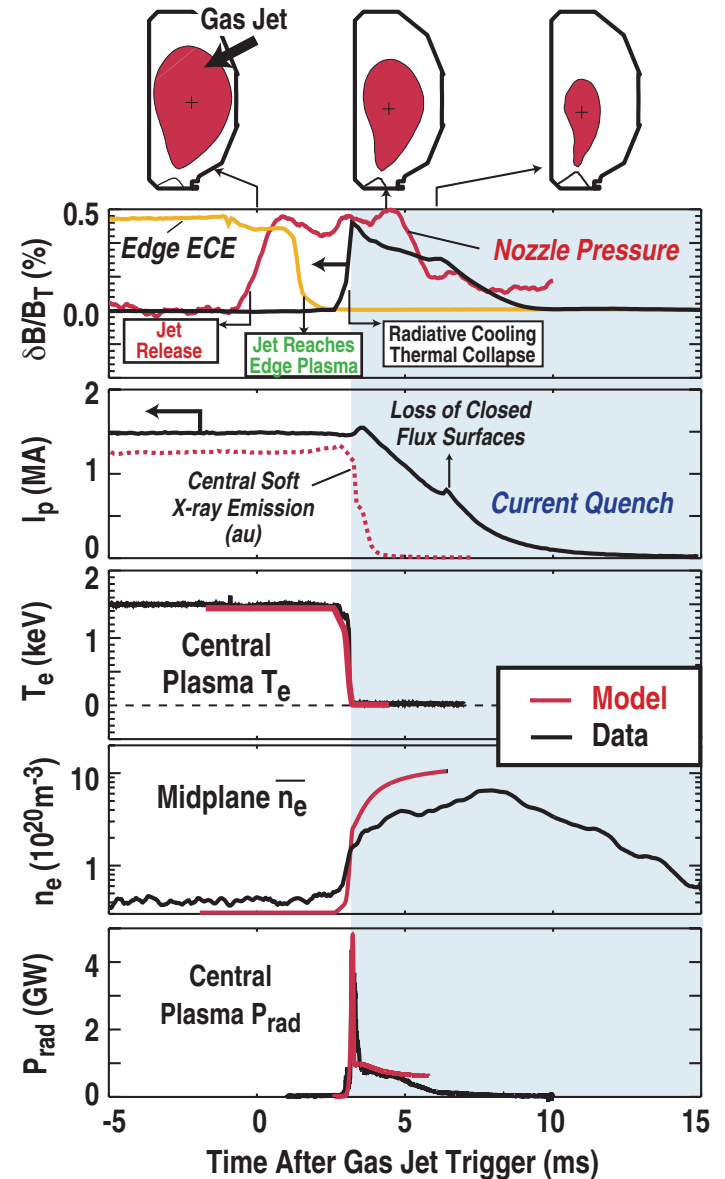

# QDB REGIME COMBINES CORE TRANSPORT BARRIER WITH QUIESCENT EDGE BARRIER – “QUIESCENT DOUBLE BARRIER”

- Edge pedestal elevates central temperatures, improving fusion performance

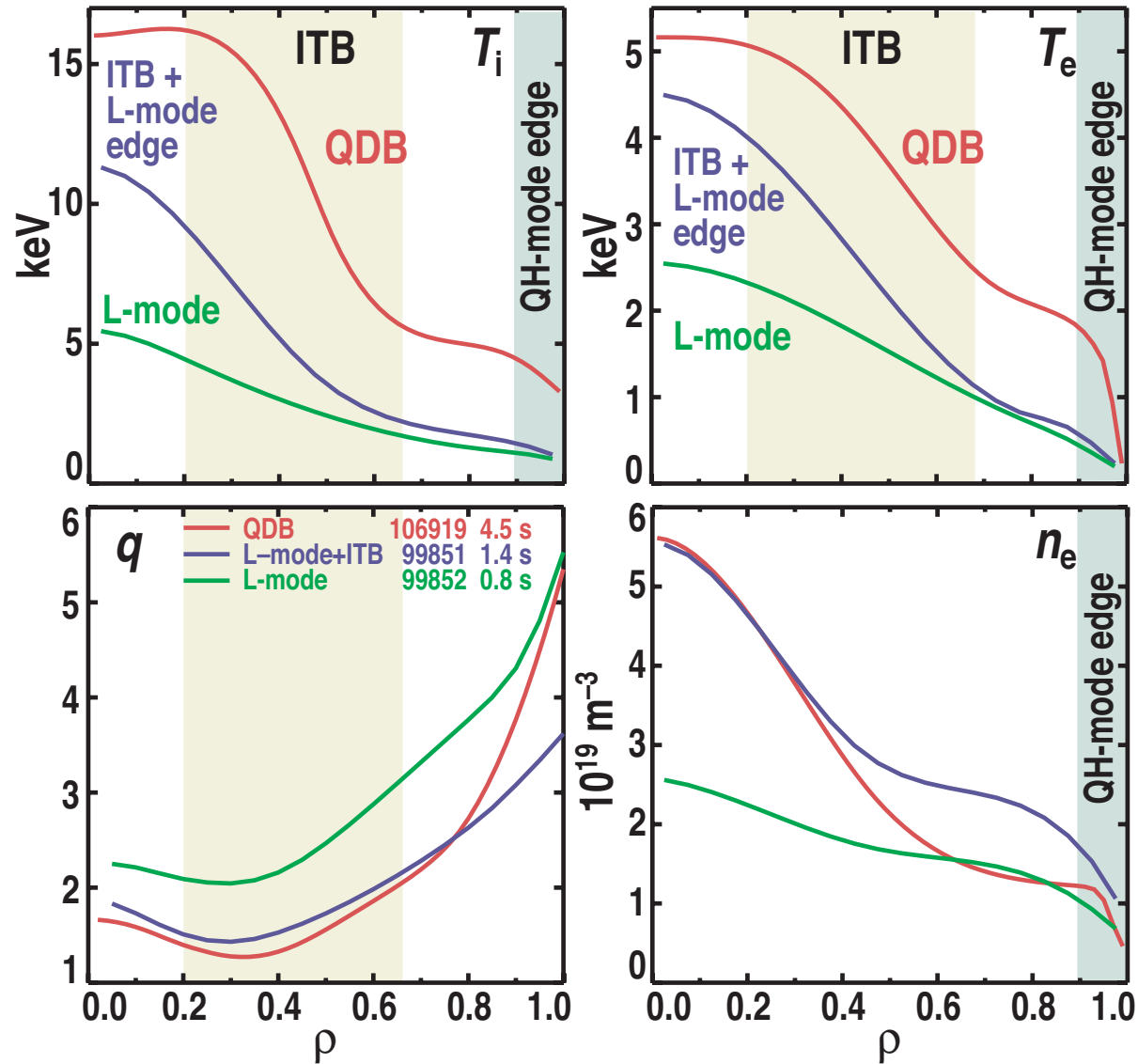

# PREDICTING THE H-MODE PEDESTAL HEIGHT AND WIDTH IS A CRITICALLY IMPORTANT RESEARCH TOPIC THAT SPANS THE TOPICAL SCIENCE AREAS

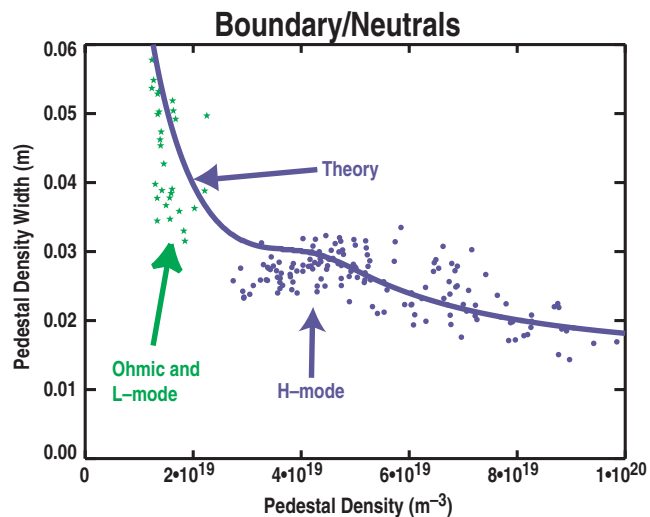
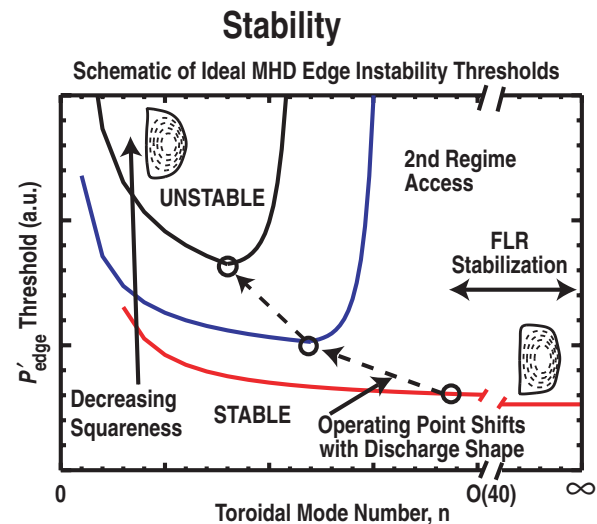
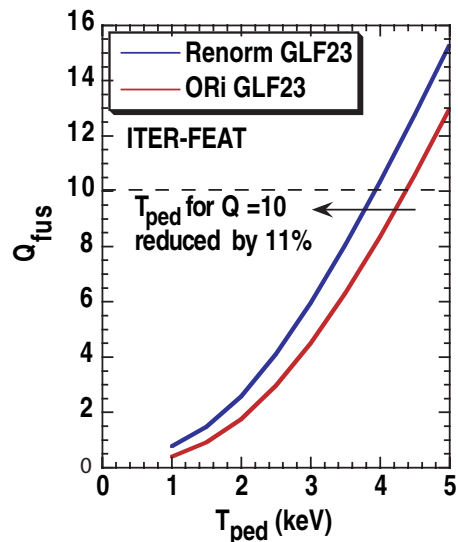
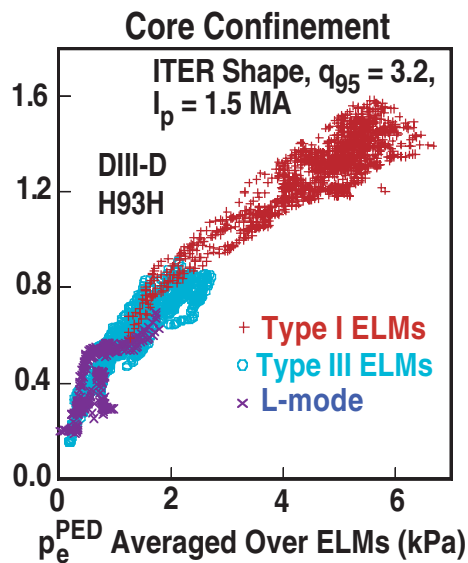

- Pedestal height and width
- Develop & test models
- Optimize & control
- ★ Pellet
- ★ Co-counter NBI
- ★ Ergodization
- ★ Li beam pol.arimetry

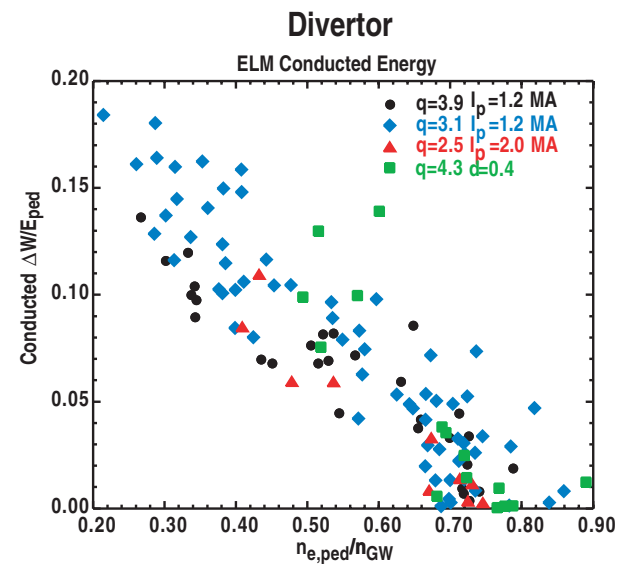

# Dimensionless similarity comparisons to investigate underlying physics

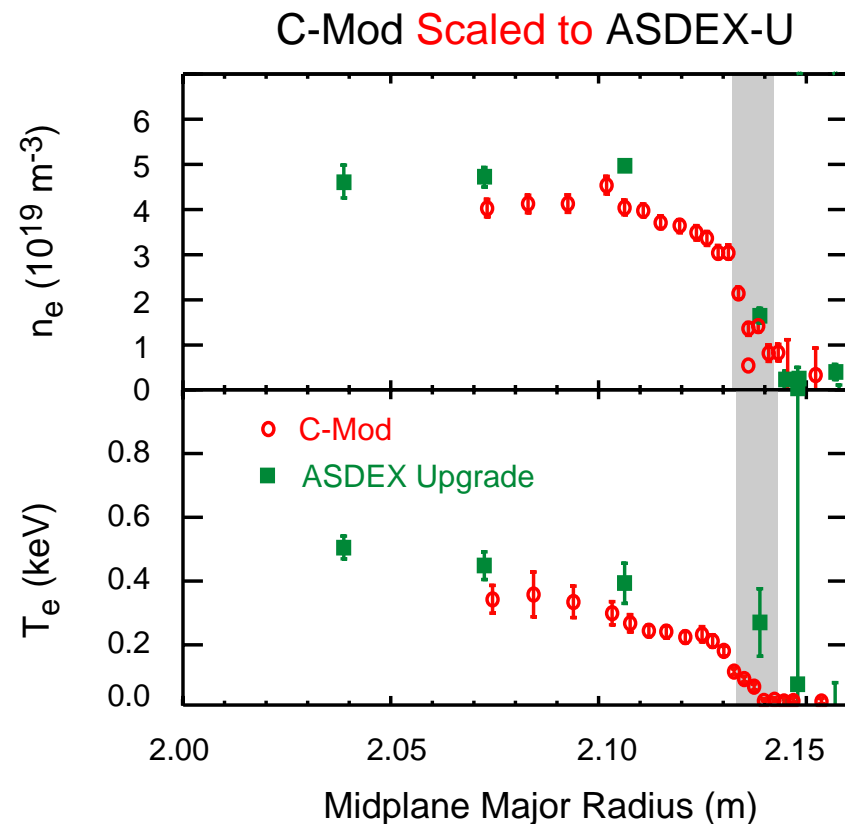
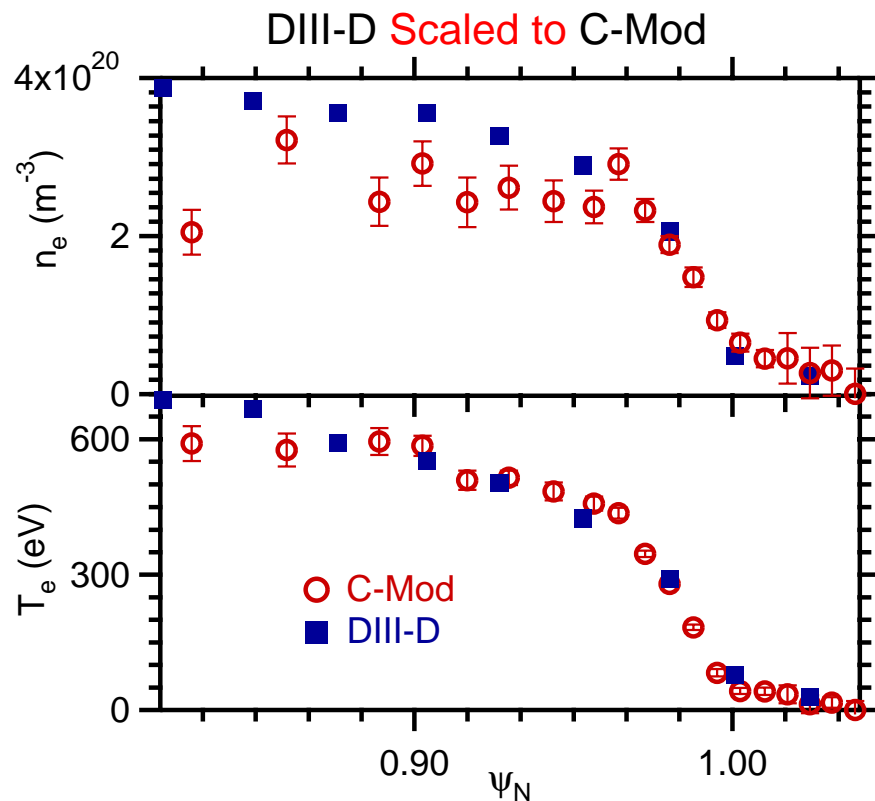

- Match  $\rho^*$ ,  $v^*$  and  $\beta$  at top of pedestal (plus shape,  $q_{95}$ )
- Detailed comparisons between entire profiles may reveal relative importance of plasma and atomic physics
- C-Mod provides the high-B, low-a end of cross-machine comparisons

# THE DIII-D PROGRAM PLANS A FOCUSED EFFORT ON UNDERSTANDING TURBULENT TRANSPORT TOWARD MEETING OUR 5 AND 10 YR IPPA GOALS

---

— As part of a community-wide effort, in concert with TTF —

- Lead goal is predictive understanding of transport (FESAC goal 1.1)
  - Five-Year Objective: Advance the scientific understanding of turbulent transport, forming the basis for a reliable predictive capability in externally controlled systems
- National cooperation and leadership (TTF)
- For the first time, codes contain essential physics needed for meaningful comparison with experiment
- Community-wide transport/diagnostic initiative is needed to fully realize the potential for improved predictive understanding of transport and get more science out of existing facilities

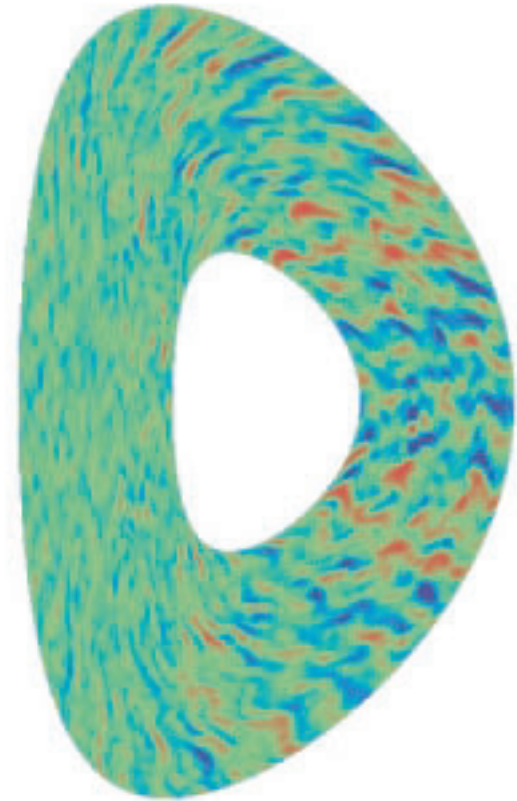

# **TURBULENCE AND TRANSPORT STUDIES ARE A CENTRAL SCIENTIFIC ISSUE TO FUSION ENERGY SCIENCES PROGRAM**

---

- “...to fully understand micro-turbulence ... requires remote measurements of local fluctuations in density, temperature, magnetic field, and electrostatic potential...further development of diagnostic tools is needed in order to be able to make detailed comparisons with turbulence theory”

— National Research Council, 2000

- “Temporally and spatially resolved profile measurements and new turbulence diagnostic measurements are required to accurately determine this complex transport behavior and differentiate the turbulence mechanisms responsible for the difference transport channels together with the profiles of the heating and fueling sources”

— Integrated Program Planning Activity, 2000





# THE TRANSPORT TASK FORCE ADVOCATES A NATIONAL TRANSPORT INITIATIVE

---

Significant transport progress to date limited mainly to ion thermal conduction

✓ means better than half way to successful completion of goal

Crucial goals	Ion thermal	Elec. thm.	Particle	Momentum	H-mode/Ped
Characterize	✓				✓
Understand	✓				
Control/Predict	✓				

---

⇒ Existing diagnostics, capabilities not suited for solving remaining problems

- Identify focus area, attack with funding increment
- Focus not to drain efforts from existing transport studies
- For new diagnostics, better use of existing diagnostics, theory, modeling
- ~\$5-10 M/year for 5 years for worthy projects on basis of proposal competition

# THE GYRO CODE INCLUDES ESSENTIAL PHYSICS BUT 10× COMPUTING POWER NEEDED

- Continuum gyrokinetic code (GYRO) includes
  - Kinetic ions and electrons at finite beta
  - Complete two-dimensional geometry
  - Profile variation ( $q$ ,  $T_e$ ,  $T_i$ ,  $E \times B$  shear, etc.)
  - Finite gyroradius
  - Self-consistent  $E \times B$  shear

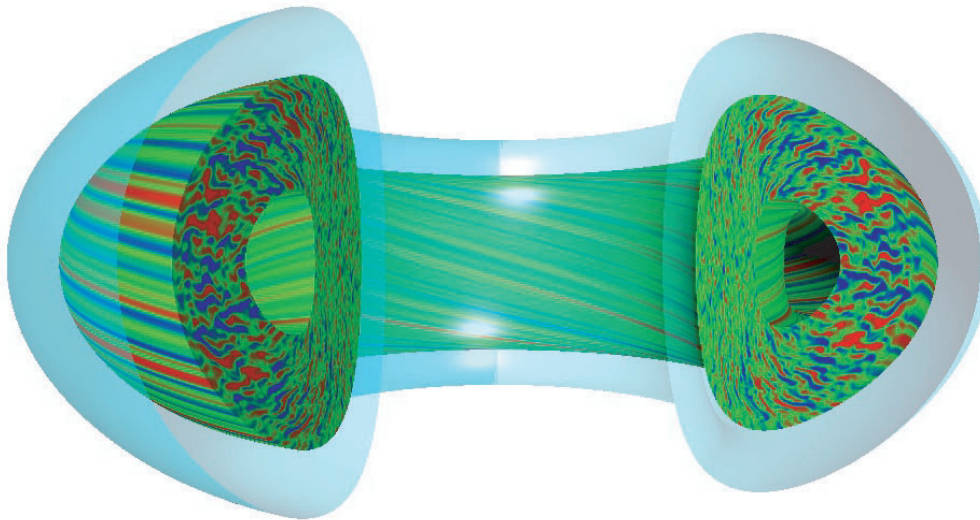

Designed and built by J. Candy

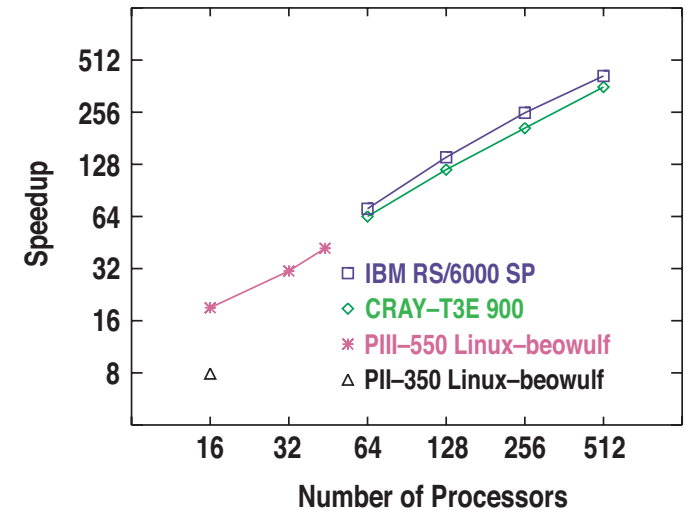

# STATE-OF-THE-ART DIAGNOSTICS ARE BRINGING NEW INSIGHTS INTO UNDERSTANDING PLASMA TRANSPORT

Simulation  
(BOUT  
code)  
Density  
fluctuations  
near the  
edge

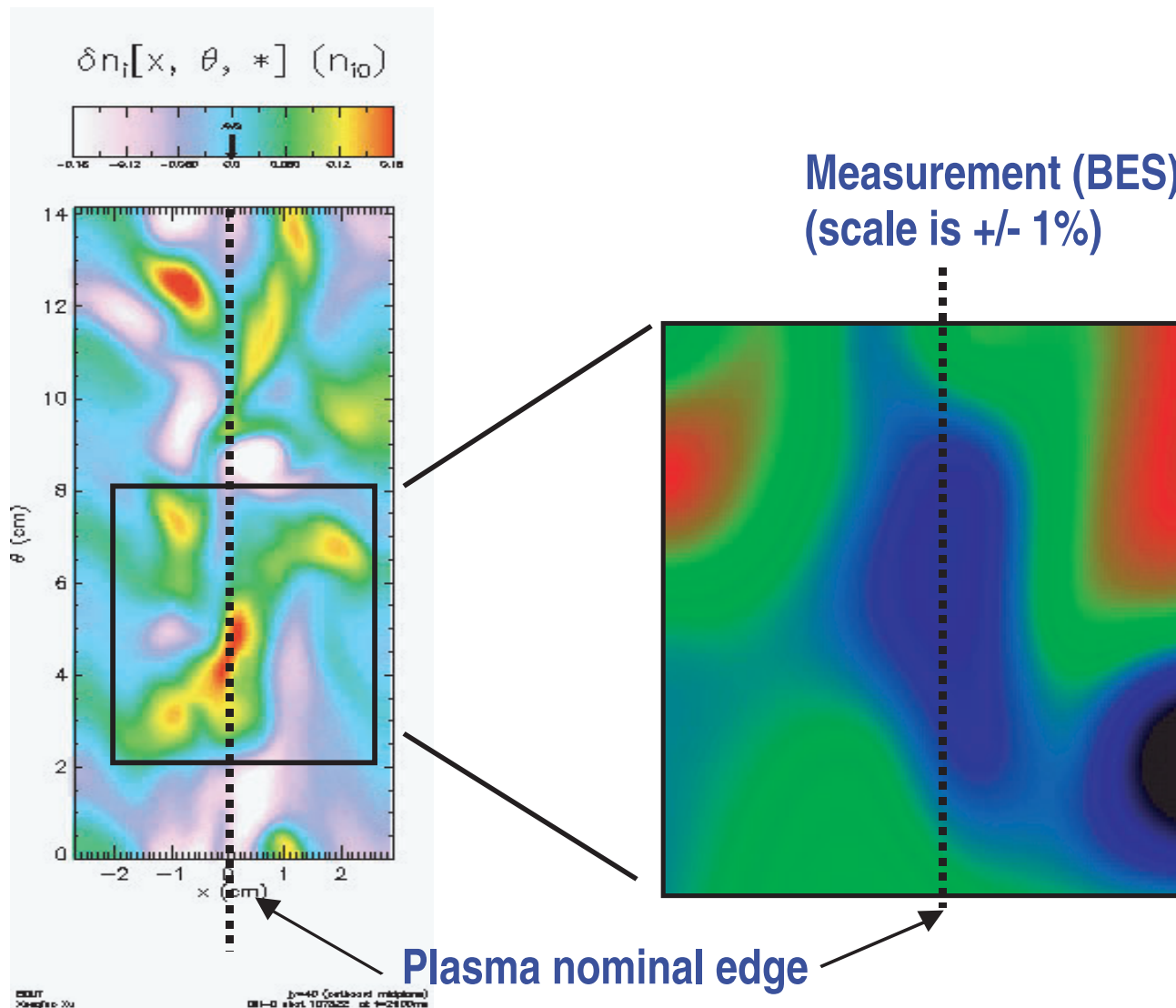

# Bursty edge particle transport implicated in empirical density limit

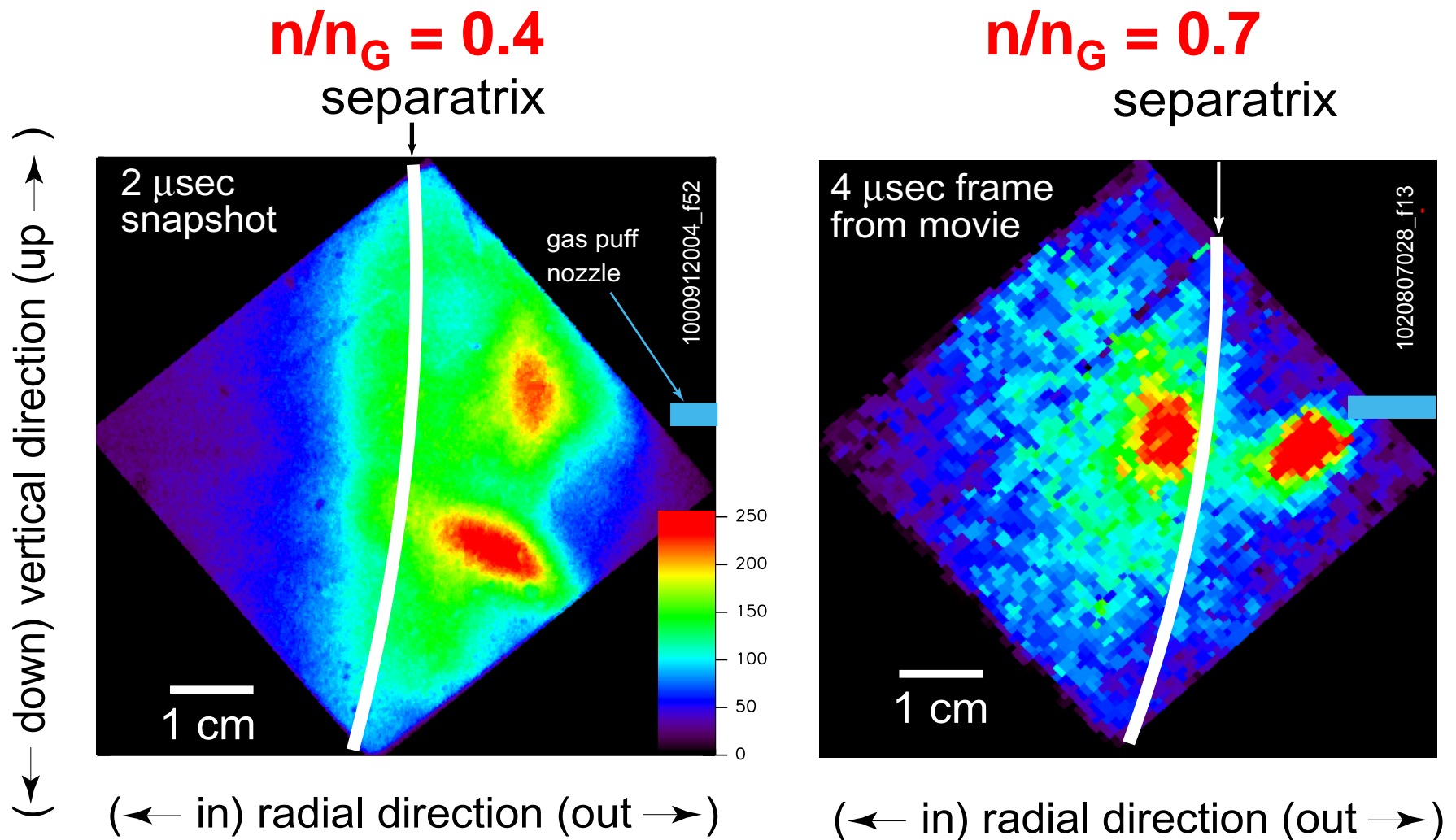

Close to limit, large eddies invade the separatrix

# WE ARE CONFRONTING NEW CHALLENGES IN PHYSICS MEASUREMENTS

Not measurable, yet

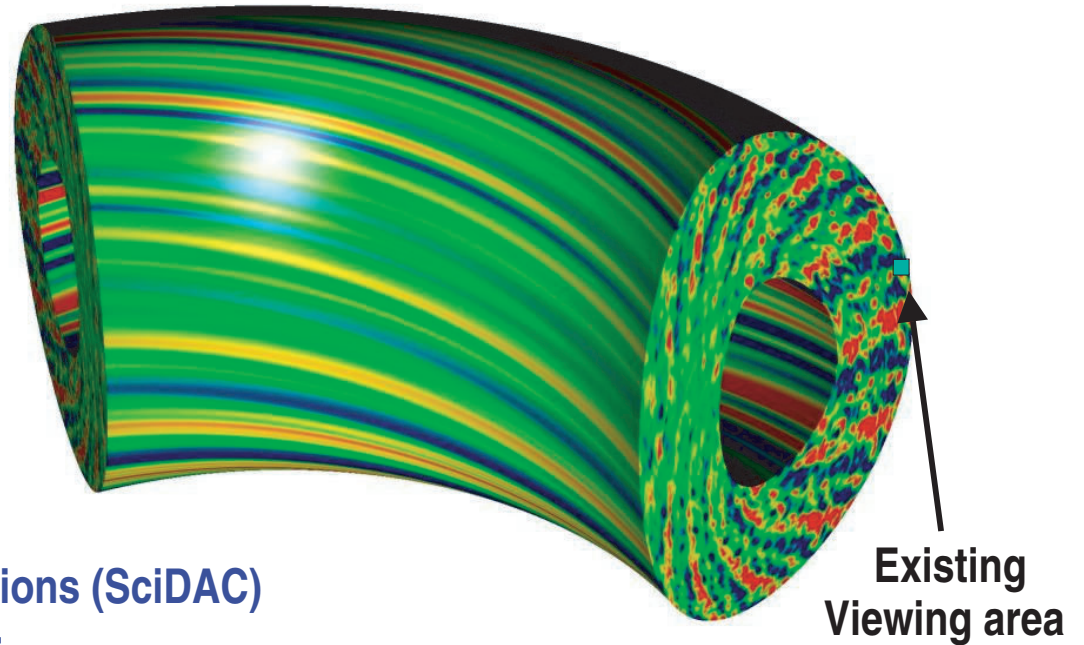
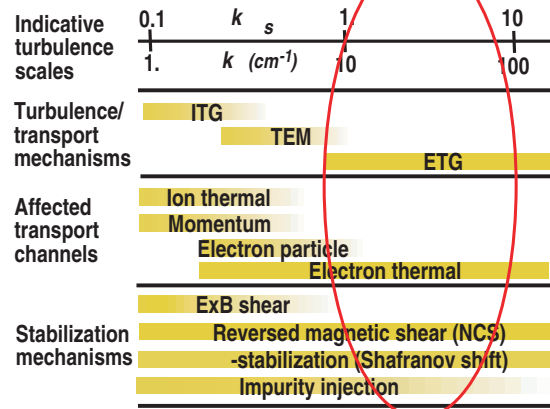

- More complex, non-linear simulations (SciDAC)
- Need new generation of diagnostics
  - Measure new parameters
  - New Physical scale (ion  $\Rightarrow$  electron gyroradius)
  - New Temporal scale
  - Increase Spatial Coverage
- Will require new technology such as imaging, lasers, etc.

## DOE diagnostic competition 2002

- Total of 39 proposals
  - 32 from universities/industries
  - 7 from labs
- Funded 15 of them
  - 11 out of 32 from universities/industries (corresponding to 85% in \$)
  - 4 out of 7 from labs (corresponding to 15% in \$)
  - 2M\$ extra would have covered the accepted but unfunded proposals (number of these has not been released)
- Lost 4 universities and 2 labs, but gained 1 lab in the process.
- 9 programs on DIII-D, C-Mod and NSTX
- 4 on ICCs
- 4 on European tokamaks
- Majority were renewals.

# A Renewed Diagnostic Initiative is needed for the US Fusion Science Program

- A \$10M/yr need is based on specific diagnostic proposals made by the MFE community at the Field Work Proposal presentations in March 2002.
- Would address 2 categories of needs
  - Short term: known techniques, insufficient resources
    - Tokamaks: specific needs to meet goals and fulfill mission
    - ICCs: basic needs to validate their individual concept
  - Long term: undeveloped techniques
    - Need longer term development (~5 yr)
    - Include some audacious ideas, higher risk

# COMPLETE AND ACCURATE PHYSICS MEASUREMENTS ARE THE KEY TO GOOD SCIENCE

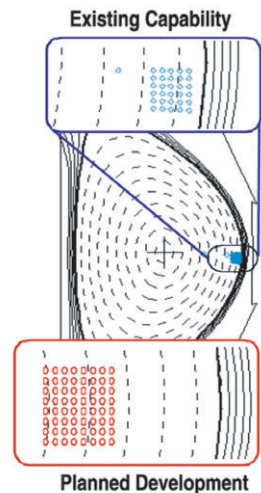

## Proposed New Measurements

- Edge  $J(r)$ , lithium beam polarimetry
- Advanced multi-fluid 2-D optical turbulence measurements (Wisc)
  - $\tilde{n}, \tilde{v}_r, \tilde{v}_\theta$  (BES)
  - $\tilde{T}_i$  (CHERS)
- Enhanced spatial high  $k$ - scattering (UCLA)
  - $\tilde{n}, 10 < k < 40 \text{ cm}^{-1}$ , spatially localized
- Phase contrast imaging (MIT)
  - $\tilde{n}, k < 100 \text{ cm}^{-1}$
- Turbulence imaging
- Boundary flows (divertor DNB)
- Fast ion (3 MeV proton, cx neutral)

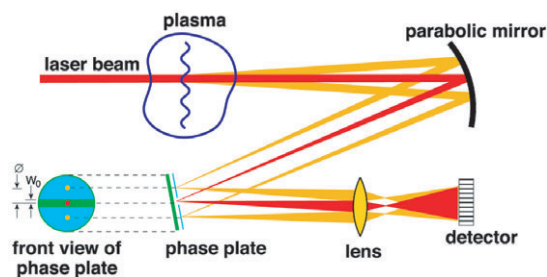
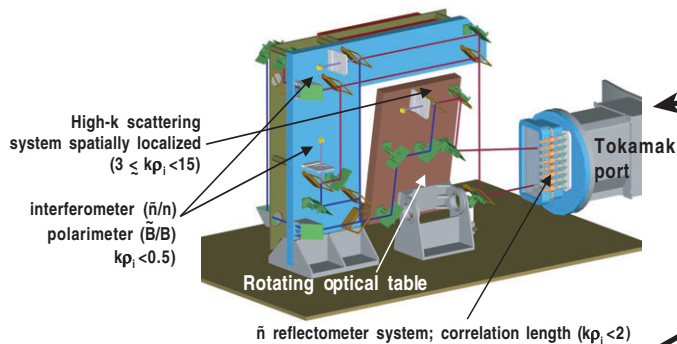



# Urgent diagnostic and facility upgrades deferred for lack of resources and manpower



- New Diagnostics and Upgrades include
  - Long pulse diagnostic neutral beam
    - Upgrades to associated MSE and CXRS systems
  - Electron-scale turbulence diagnostic(s)
  - Polarimetry
  - Reflectometry upgrade
  - Divertor IR imaging
  - SOL flow imaging
- Facility Upgrades
  - Phase II of LHCD
  - Load tolerant real-time ICRF matching system
  - Data acquisition and computing
- Including personnel, ~ \$2M/year for 5 years

## ITER offers an opportunity and a challenge for diagnostics

- Many diagnostics will be used in control/feedback mode
  - Must be reliable and stable for proper control
- Environment is a challenge (active R&D program)
  - Radiation limits materials, access; introduces additional effects (RIEMF, RIC, nuclear heating)
  - Erosion/deposition may affect lifetime, calibration, stability
  - Beam-based diagnostics may have penetration/attenuation issues (e.g. DNB)
- Access has limitations (#ports and need for shielding)
  - Coverage and resolution are tailored to requirements and access.

## ITER critical diagnostic needs

- All alpha particle diagnostics
  - Very critical area -- has been recognized as high priority item (ITPA)
  - Recently, neutron profile became an issue as well (lost vertical camera)
- Current profile
  - Much progress recently - downgraded to medium priority now
- Turbulence diagnostics
  - Access is very difficult for those measurements
- AT diagnostic needs
  - Requirements being revisited, could be a challenge with local gradients (ITB and pedestal); topic at the next ITPA-diagnostic meeting (Feb 2003)
  - Electric field measurements - still a challenge with respect to requirements.
- Flows and ion temperature in divertor area, same issue as in existing tokamaks

## DIII-D better suited than ITER for some studies

- Transport:
  - Small scale turbulence (density, temperature, potential, magnetic)
    - Localization of turbulence still an issue
    - Cross-phase of turbulence (which we can get fluxes)
  - Imaging turbulence
- Boundary:
  - Flows and Ion temperature
  - Measure erosion/deposition
  - Hydrogen (tritium) retention

# BOUNDARY PHYSICS: UNDERSTAND MASS TRANSPORT

- FESAC/IPPA 5-Year Objective: Advance the capability to predict detailed multi-phase interfaces at very high power and particle fluxes
- DIII-D Goal  
Understand the physics of “mass transport” in the SOL, plasma chamber and develop techniques to affect and control the flows of particles around the boundary of divertor tokamaks
- Applications: radiative divertor, T co-deposition problem

- Measure particle sources, sinks and flow channels
  - ★ In-situ diagnostics
- Erosion, redeposition
  - ★ ELMs
- Integrated boundary modeling, divertor plate to the pedestal top
  - ★ Quantify tritium retention
  - ★ Devise mitigation

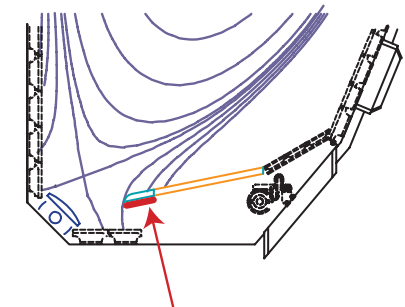
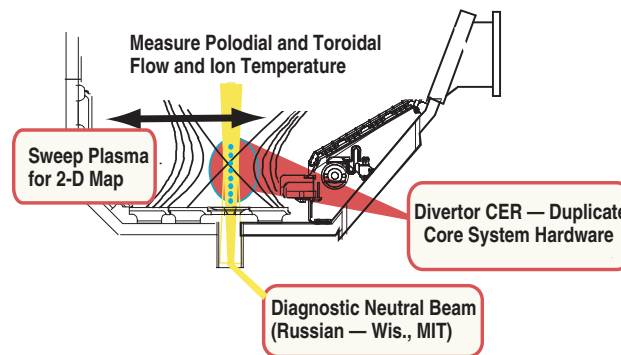

$n_e$  Without Drifts UEDGE Fluid Code

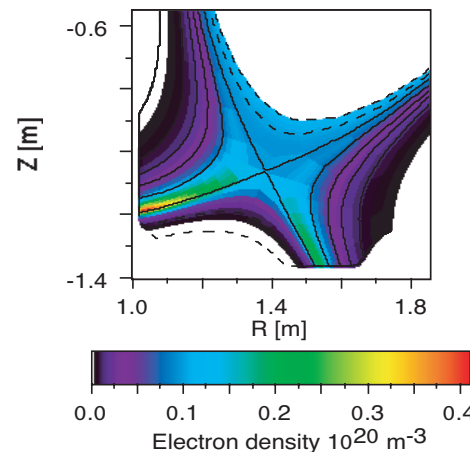

$n_e$  With Drifts UEDGE Fluid Code

Increased Density Due to Particle Drifts in Private Flux Region

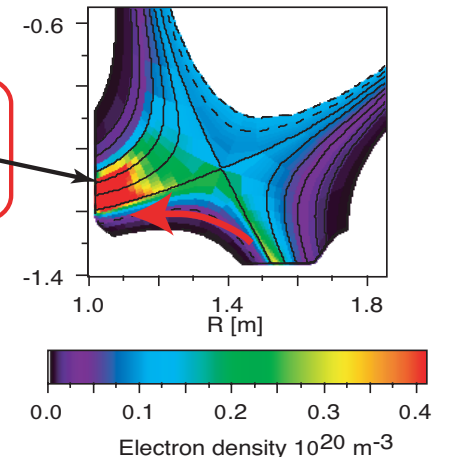

# BOUNDARY CONTROL: EVOLVING DIVERTOR HARDWARE SUPPORTS

## BOUNDARY DIVERTOR PHYSICS AND ADVANCED TOKAMAK NEEDS

To Present

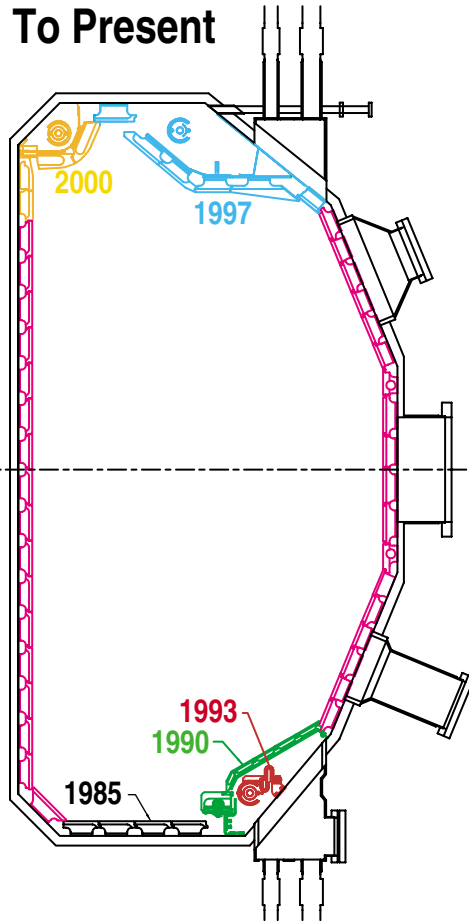

Options

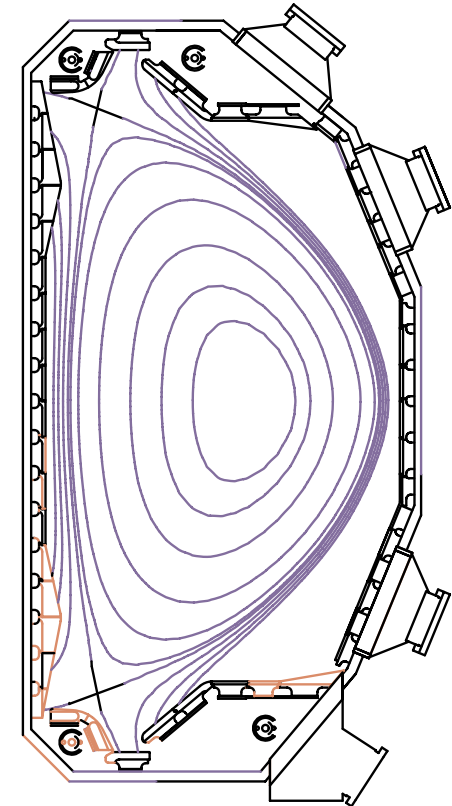
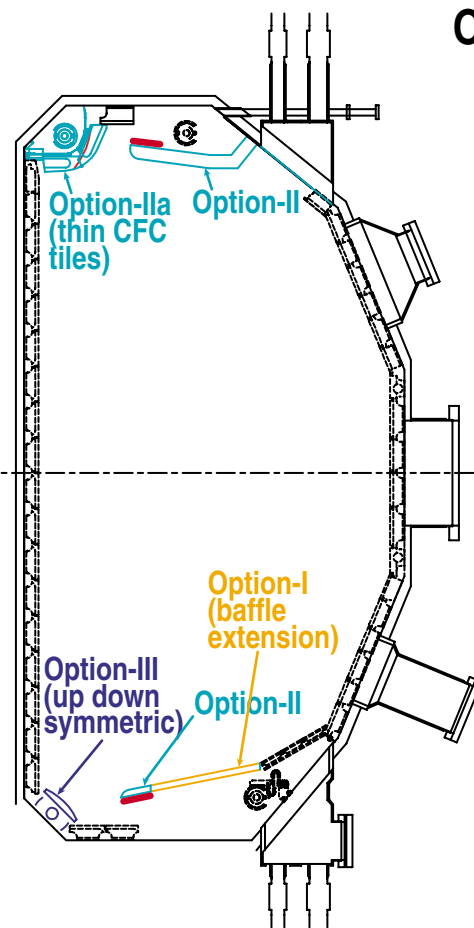

# DIII-D and C-MOD add complementary elements to the world tokamak divertor program

## DIII-D

- H-mode particle control
- Erosion/Redep in carbon
- DN, open & closed divertor
- New flow diagnostic
- Detailed modeling

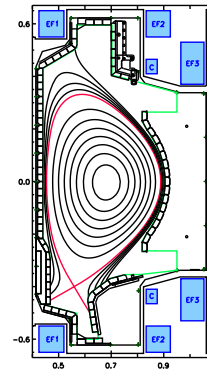
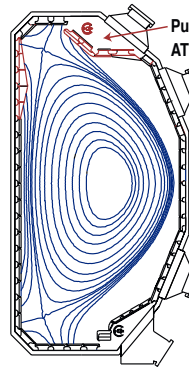

## C-Mod

- High  $n_e$  plasmas
- Moly walls
- Main chamber vs. divertor particles
- New diagnostics & improvements ...

## JT-60U

- Divertor dome
- AT plasmas
- Flows w/ probes
- Pumping

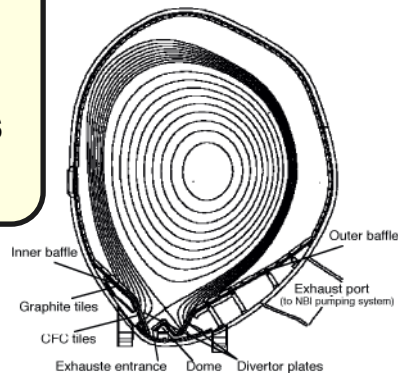

## ASDEX-U

- Tungsten walls
- AT plasmas & shapes
- Pumping

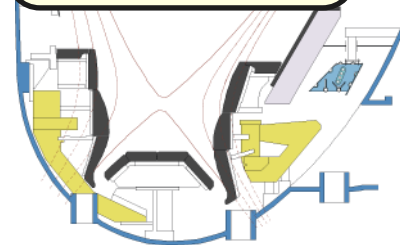

## JET

- Divertor shapes
- Carbon walls
- Helium plasma
- Tritium retention

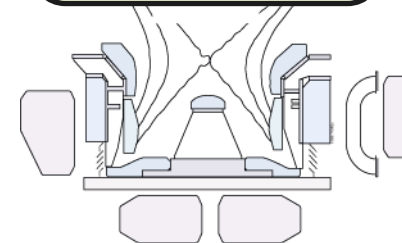

# ADVANCED TOKAMAK RESEARCH

## *Realizing the Ultimate Potential of the Tokamak*

- Improvement of the tokamak concept toward

- Steady state
  - Self-generated bootstrap current
  - Current drive
  - Boundary optimization
- High power density
  - Improved stability
- Compact (smaller)
  - Improved confinement

Simultaneously  
integrated

- A self-consistent optimization of plasma physics through

- Magnetic geometry (plasma shape and current profile)
- Plasma profiles (current, pressure, density, rotation, radiation,...)
- MHD feedback stabilization

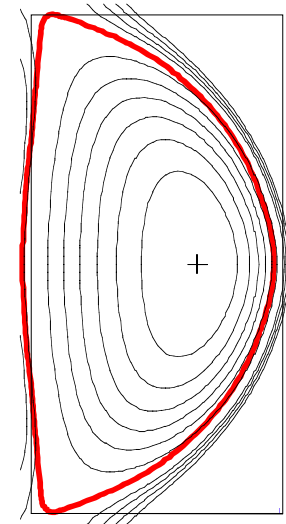
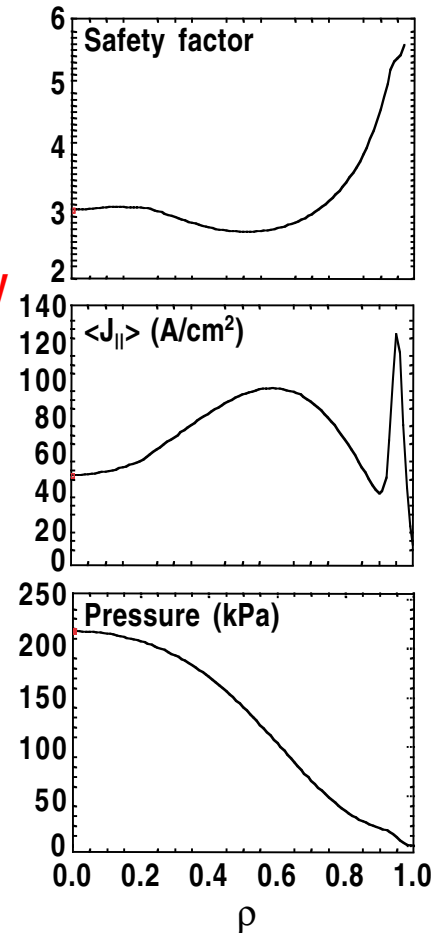

$I_p = 1.56 \text{ MA}$      $\beta_T = 7.15\%$   
 $B_T = 1.85 \text{ T}$      $\beta_N = 5.12$   
 $q_{95} = 5.50$   
 $q_0 = 3.00$   
 $q_{\min} = 2.70$   
 $f_{BS} = 0.96$



# INTERNAL TRANSPORT BARRIER CONTROL IS ESSENTIAL

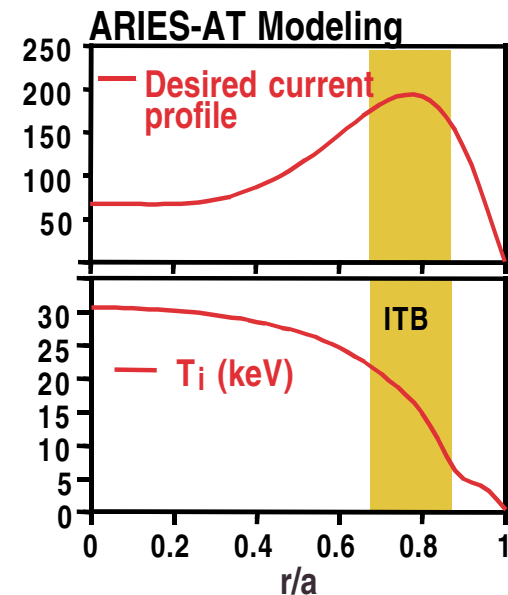
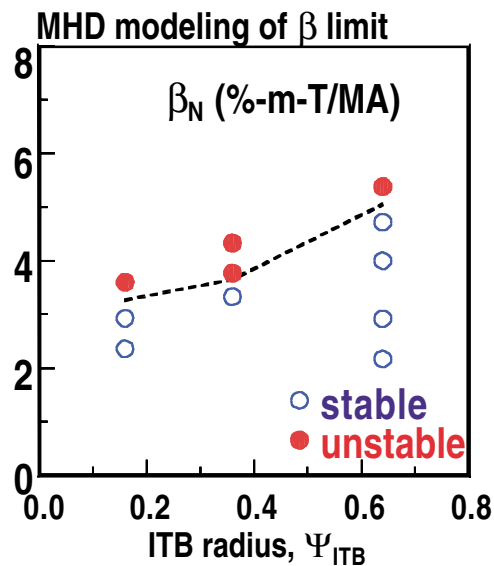
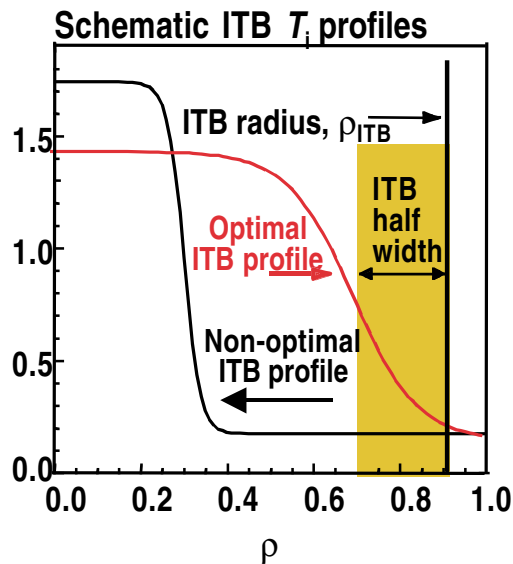

- Fusion performance: Need to maximize volume inside barrier.
- MHD stability: Beta limit maximized with barrier location and width.
- Bootstrap current: Better aligned with larger barrier position.
- *Large barrier radius and large barrier width both highly desirable.*

# SIGNIFICANT PROGRESS TOWARD LONG-PULSE HIGH PERFORMANCE

● Advanced performance found in many operating regimes

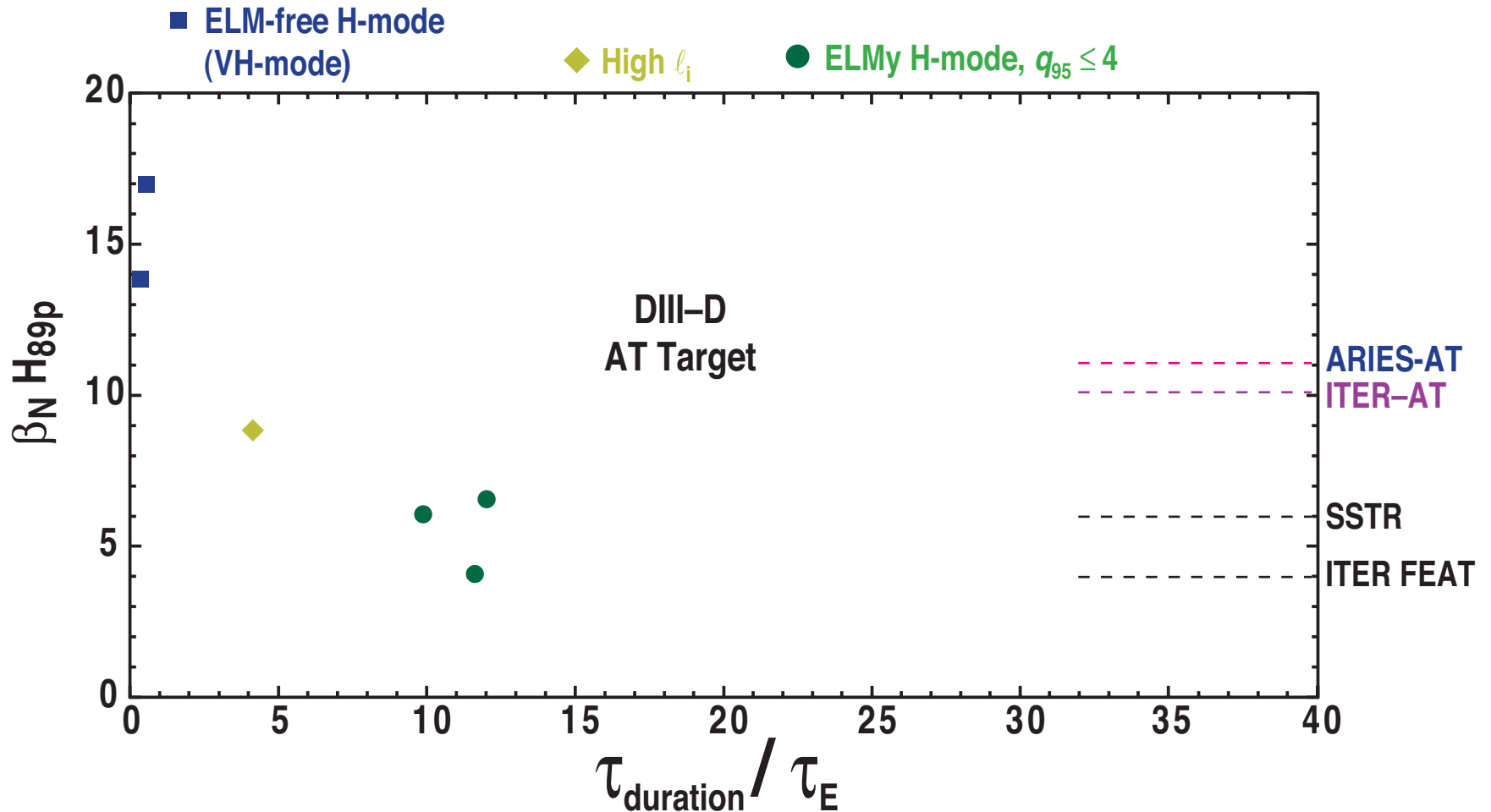

# SIGNIFICANT PROGRESS TOWARD LONG-PULSE HIGH PERFORMANCE

● Advanced performance found in many operating regimes

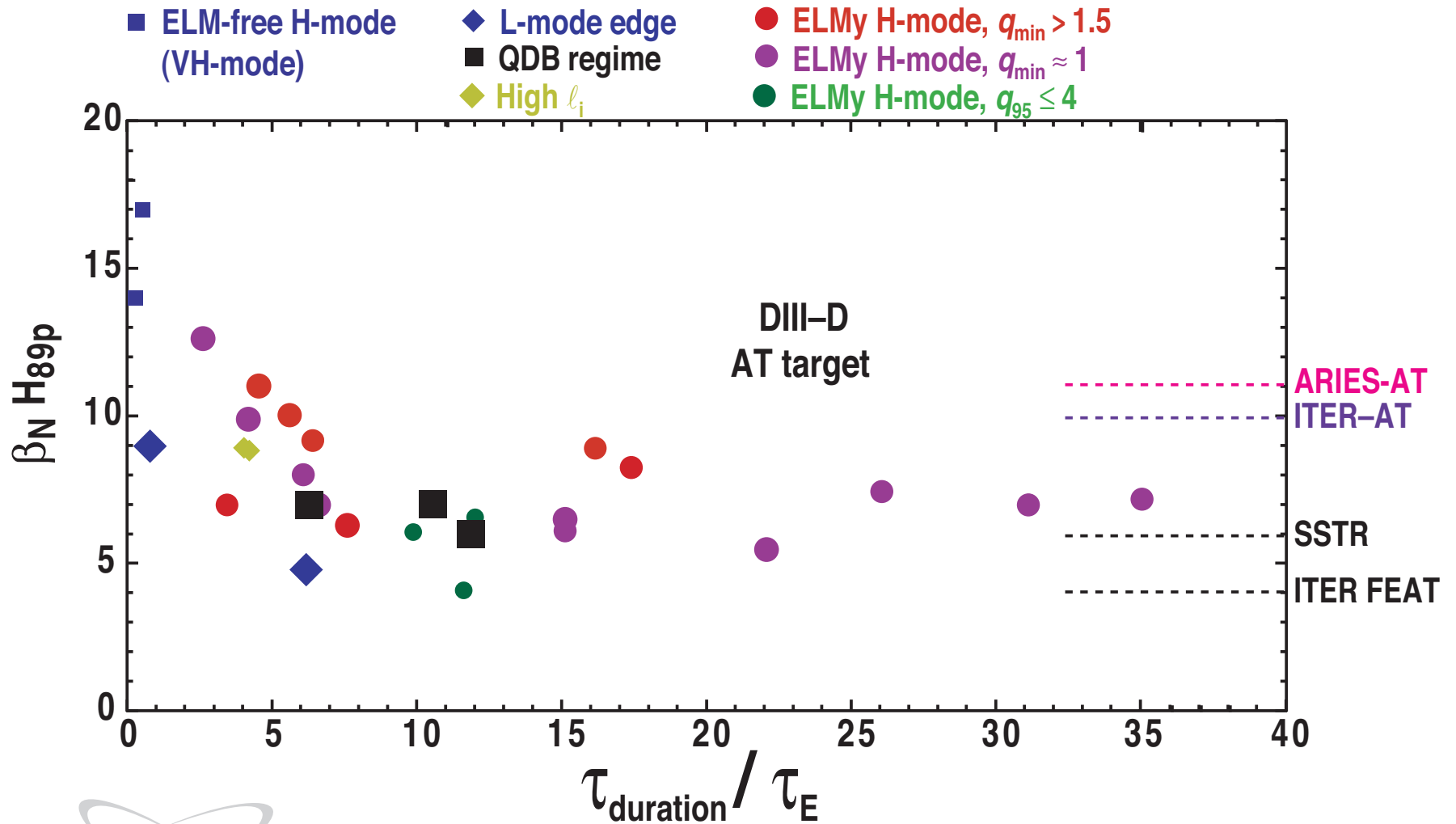

# ADVANCED TOKAMAK PHYSICS IS CLOSE AT HAND

---

- **Building blocks nearly in place**
  - Wall stabilization looks like it will work
  - Neoclassical tearing mode stabilization with ECCD works
  - Current profile control demonstrations have started
  - Enhanced confinement states abound
  - ELM free regimes found (EDA in Alcator C-MOD, QH in DIII-D)
  - New era of plasma control starting
  - Disruption mitigation technique available
- **Basis for steady-state operation of ITER, and DEMO at  $\beta_N = 4$ ,  $H_{99} \sim 2.5-3.0$  achievable in 4–6 years**
  - If major facilities are adequately support (+30% budget increase)
    - ★ more run time
    - ★ more plasma control tools
    - ★ adequate theory and computational support
- **Ultimate potential ( $\beta_N \sim 5$ ,  $H_{99P} \sim 3.5$ ) takes longer**



# STATIONARY PLASMAS THAT WOULD ENABLE ITER TO RUN 4000 SECONDS AT 500 MW FUSION POWER HAVE BEEN DEMONSTRATED ON DIII-D

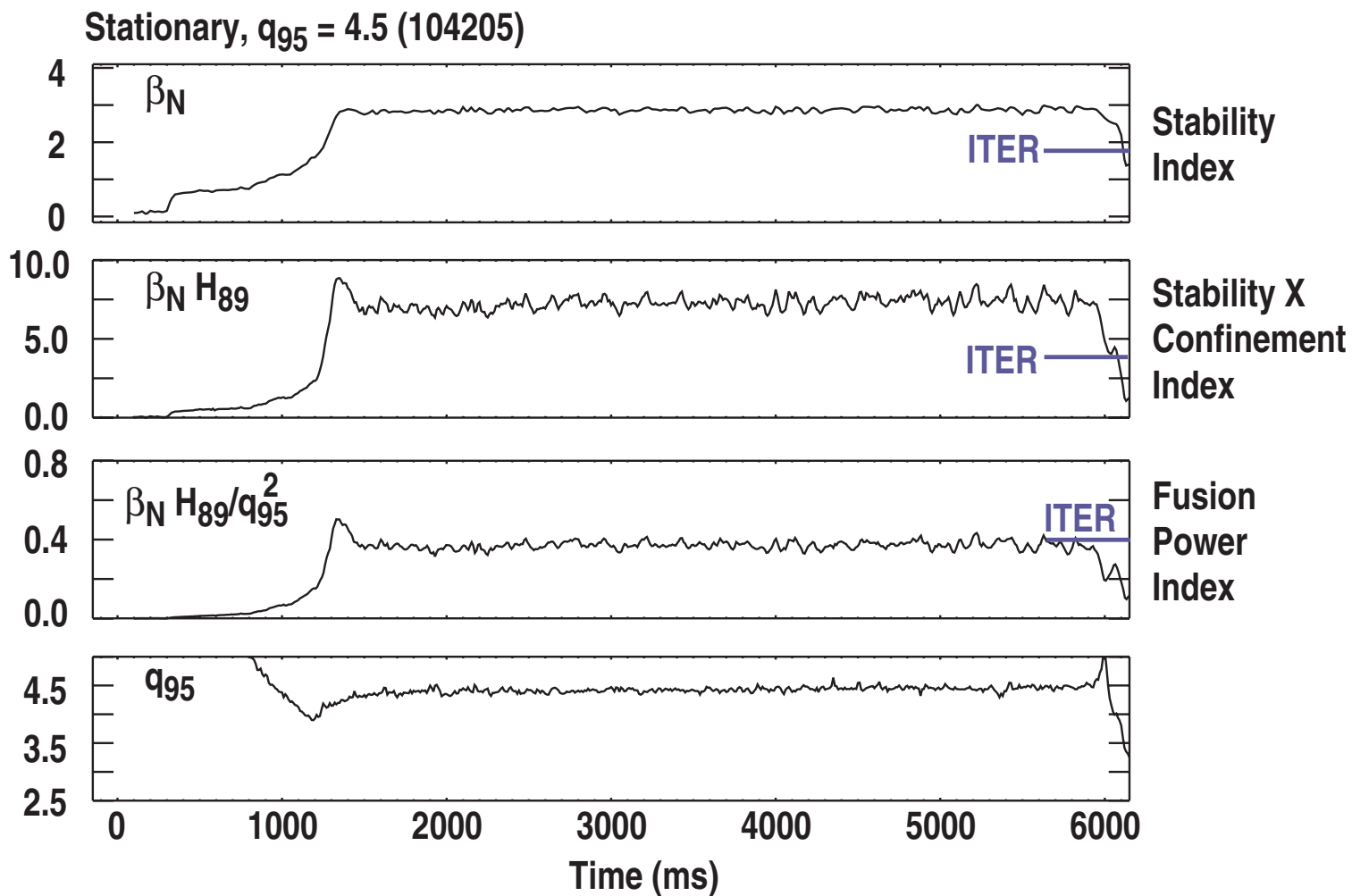

# SHALLOW SHEAR REVERSAL AT $q_0$ AROUND 1: HIGH FUSION YIELD HYBRID ITER SCENARIOS

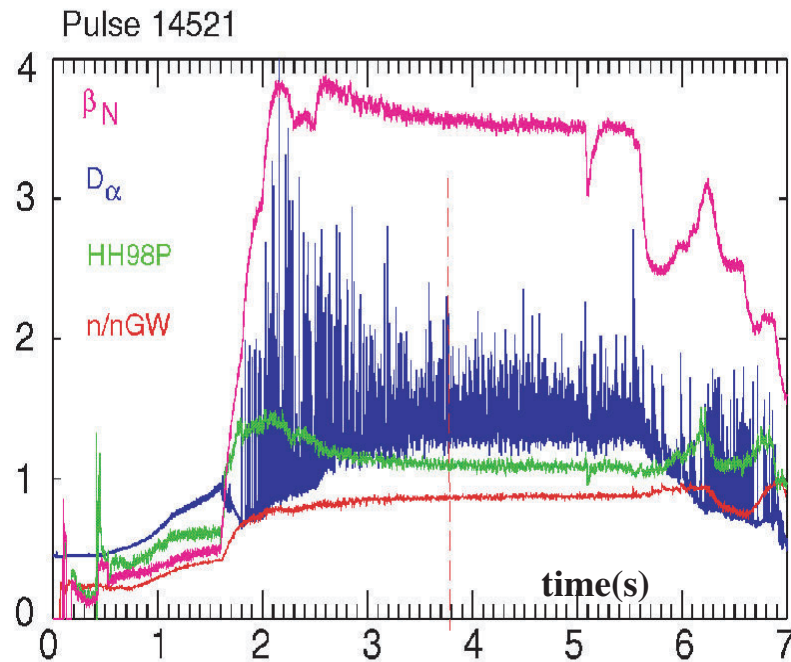

In AUG with NBI +off-axis NBCD  
 high  $\beta_N$  at  $q_{95}=3.6$ ,  $H_{98}=1.3$ ,  $n/n_G$   
 $\sim 1$ ,  $I_{BS}/I_P \sim 0.6$  and type II ELMS

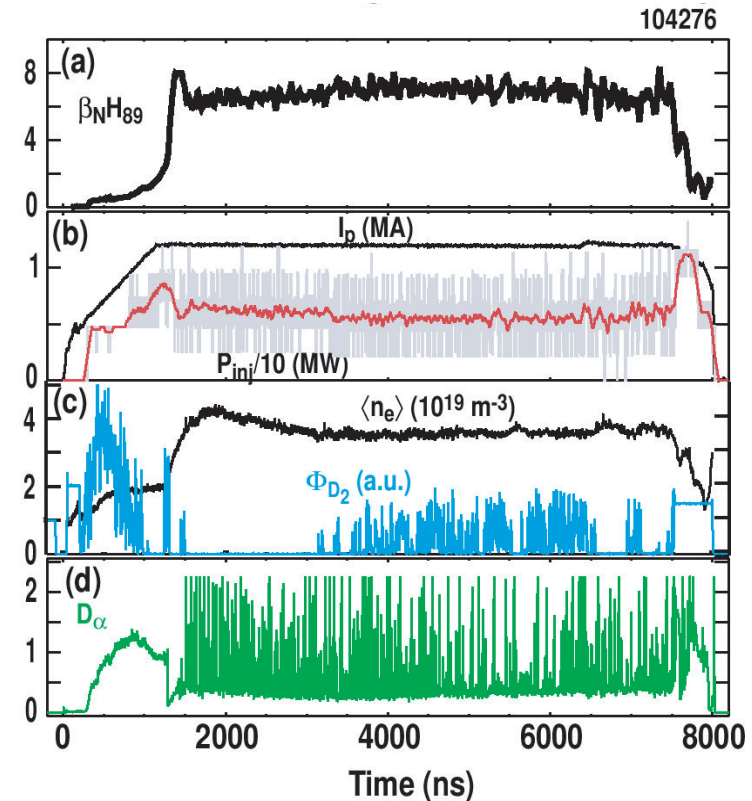

DIID: High performance sustained  
 for  $35 \tau_E$  ( $t_{relax}=1.8\text{s}$ )

In both machines: no sawteeth. Question:  
 How to maintain  $q_0$  very close to 1: Are fishbones(AUG) or mild tearing  
 modes (DIID) acceptable in a BPX?

# RECENT DIII-D EXPERIMENTS HAVE DEMONSTRATED THE ABILITY TO CONTROL THE CURRENT PROFILE IN HIGH PERFORMANCE DISCHARGES USING OFF-AXIS ECCD

## High Bootstrap Fraction AT

$I_p$	1.2 MA	
ECCD	0.13 MA	10%
NBCD		30%
Bootstrap		<b>53%</b>
OHMIC		7%
Non-Inductive		<b>93%</b>
$B_T$	1.85 T	
EC	2.5 MW	
NB	8 MW	
$B_T$	3.1%	
$\beta_N$	2.8	
H	2.5	
$\beta_{NH}$	7	

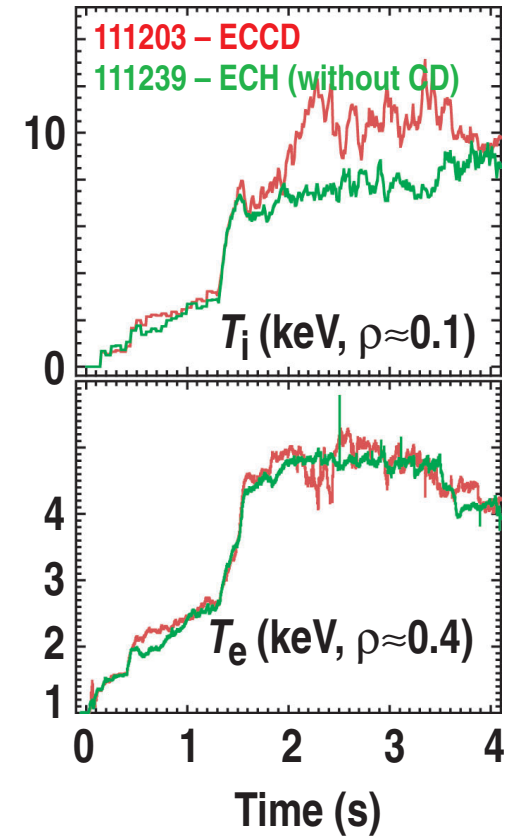
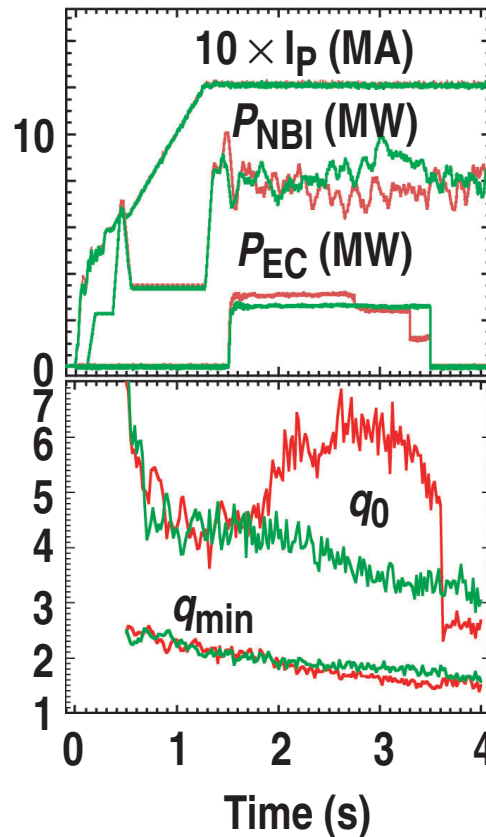

# ITER BASELINE SCENARIOS ARE CONSERVATIVE

Q= 10 reference scenario(s): milestone

Parameter	400 MW	560 MW	260 MW
R/a (m/m)	6.2/2.0	←	←
$\kappa_{95}/\delta_{95}$	1.7/0.33	←	←
$B_T$ (T)	5.3	←	←
$I_p$ (MA)	15.0	←	←
$q_{95}$	3	←	←
$\langle n_e \rangle$ ( $10^{20} \text{ m}^{-3}$ )	1.01	1.18	0.83
$\langle n_e \rangle / n_G$	0.85	1.0	0.7
$\langle T_e \rangle$ (keV)	8.8	9.0	8.7
$\langle T_i \rangle$ (keV)	8.0	8.2	7.9
$P_{FUS}$ (MW)	400	560	260
$P_{NB} + P_{RF}$ (MW)	33 + 7	33 + 23	17 + 9
Q	10	←	←
$P_{RAD}$ (MW)	47	71	30
$P_{LOSS}/P_{L-H}$	1.8 (87/48)	2.4 (124/53)	1.3 (55/42)
$\beta_N$	1.8	2.1	1.4
$\beta_P$	0.65	0.77	0.52
li (3)	0.84	0.84	0.85
$\tau_E$ (s)	3.7	3.1	4.7
$H_{H98(v,2)}$	1.0	←	←
$\tau_{He}^{\dagger} / \tau_E$	5.0	←	←
$f_{He, axis/ave}$ (%)	4.3/3.2	4.1/3.1	4.1/3.1
$f_{Be, axis}$ (%)	2.0	←	←
$f_{Ar, axis}^{\dagger 1}$ (%)	0.12	0.16	0.10
$Z_{eff, ave}$	1.66	1.77	1.60
$V_{loop}$ (mV)	75	75	82

conservative requirements





# WE ARE WORKING ON ITER'S STEADY-STATE SCENARIOS

steady state  
(„advanced“)  
scenarios:

- development needed
- spectrum of scenarios
- scenarios illustrative

	Scenario 4		Scenario 6		Scenario 7
	WNS	WNS	SNS	WPS	Low-Q
R/a (m)	6.35/1.85	6.35/1.85	6.35/1.85	6.35/1.85	6.35/1.85
B <sub>T</sub> (T)	5.18	5.18	5.18	5.18	5.18
I <sub>p</sub> (MA)	9.0	9.5	9.0	9.0	11.0
κ <sub>95</sub> /δ <sub>95</sub>	1.85/0.40	1.87/0.44	1.86/0.41	1.86/0.41	1.84/0.43
<n <sub>e</sub> > (10 <sup>19</sup> m <sup>-3</sup> )	6.7	7.1	6.5	6.7	5.7
n/n <sub>G</sub>	0.82	0.81	0.78	0.82	0.57
<T <sub>i</sub> > (keV)	12.5	11.6	12.1	12.5	9.3
<T <sub>e</sub> > (keV)	12.3	12.6	13.3	12.1	12.1
β <sub>T</sub> (%)	2.77	2.67	2.76	2.75	2.2
β <sub>N</sub>	2.95	2.69	2.93	2.92	1.9
β <sub>p</sub>	1.49	1.25	1.48	1.47	0.77
P <sub>fus</sub> (MW)	356	338	340	352	174
P <sub>RF</sub> + P <sub>NB</sub> (MW)	29 + 30 <sup>*1</sup>	35 + 28 <sup>*1</sup>	40 + 20 <sup>*2</sup>	29 + 28 <sup>*3</sup>	36 + 50
Q = P <sub>fus</sub> /P <sub>add</sub>	6.0	5.36	5.7	6.2	2.0
W <sub>th</sub> (MJ)	287	292	287	284	212
P <sub>loss</sub> /P <sub>L-H</sub>	2.59	2.74	2.63	2.6	3.0
τ <sub>E</sub> (s)	3.1	2.92	3.13	3.07	2.15
f <sub>He</sub> (%)	4.1	4.0	4.0	4.0	3.0
f <sub>Be</sub> (%)	2	2.0	2	2	2
f <sub>Ar</sub> (%)	0.26	0.16	0.2	0.23	0.19
Z <sub>eff</sub>	2.07	1.87	1.89	1.99	1.86
P <sub>rad</sub> (MW)	37.6	30.6	36.2	34.6	22
P <sub>loss</sub> (MW)	92.5	100.0	91.6	92.7	99
I <sub>i</sub> (3)	0.72	0.43	0.6	0.69	0.58
I <sub>CD</sub> /I <sub>p</sub> (%)	51.9	49.7	53.7	50.2	73.6
I <sub>bs</sub> /I <sub>p</sub> (%)	48.1	50.3	46.3	49.8	26.4
I <sub>OH</sub> /I <sub>p</sub> (%)	0	0	0	0	0
q <sub>95</sub> /q <sub>0</sub> /q <sub>min</sub>	5.3/3.5/2.2	5.0/3.8/2.7	5.4/5.9/2.3	5.3/2.7/2.1	4.1/1.5/1.3
H <sub>H98(y,2)</sub>	1.57	1.46	1.61	1.56	1.0
τ <sub>He</sub> <sup>*</sup> /τ <sub>E</sub>	5.0	5.0	5.0	5.0	5.0



# WITH ADEQUATE RESOURCES, FUSION PROGRESS CAN EVOLVE RAPIDLY

---

1. Advanced Tokamak, steady-state basis could be available before ITER operates
2. First phase of ITER could focus on advanced, long pulse modes, not the conventional OH driven operation
3. Work in ITER and parallel actual long pulse work in other superconducting machines could establish steady-state operation by the end of ITER phase 1a
4. The plasma physics can be in hand for a steady-state, high performance demo and for possible use of ITER for high fluence testing of fusion energy technology

# DIII-D LONG PULSE CAPABILITY PROVIDES FOR LEADING EDGE ADVANCED TOKAMAK PHYSICS IN SUPPORT OF FESAC/IPPA 10 YR GOAL

- **FESAC/IPPA:** Assess the attractiveness of extrapolable, long-pulse operation of the advanced tokamak for pulse lengths much greater than the current penetration time

- $\tau_{CR} \approx 1.4 a^2 \kappa / Z_{eff} T_e^{3/2}$

- Near term:  $\langle T_e \rangle \sim 4$  keV  $\tau_{CR} \sim 4$  s
- Full field target:  $\langle T_e \rangle \sim 6$  keV  $\tau_{CR} \sim 7.5$  s

Device	DIII-D	JET	KSTAR	JT-60SC	FIRE	ITER
$\tau_{CR}$	7.5	50	9	25	13	250
$\tau_{pulse}$	10	20	20/300	20/300	20	400

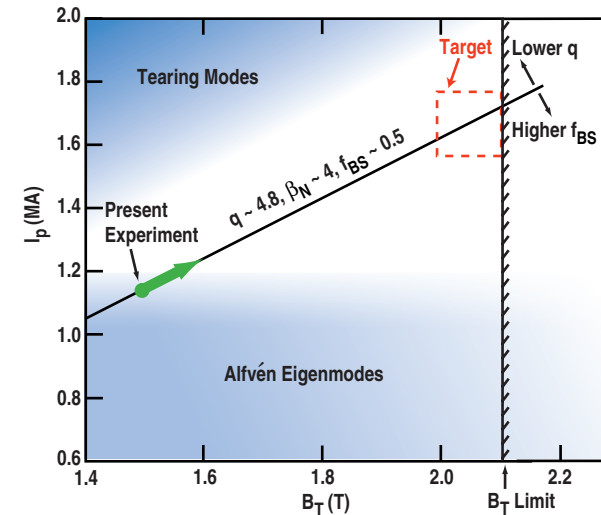

## NEEDED IMPROVEMENTS

138 kV to 12.47 kV Transformer  
84 MW Peak, 350 MW Energy Throughput

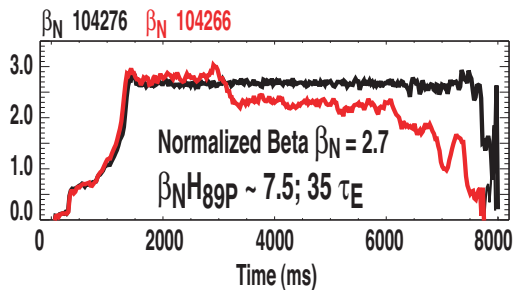

Toroidal Coil Beltbus



Toroidal Coil Freewheeling Diodes

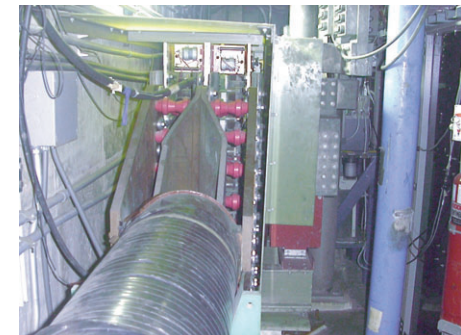

# PURSUIT OF CUTTING EDGE PHYSICS DRIVES MODIFICATIONS TO HEATING AND CURRENT DRIVE SYSTEMS

Physics Element	ECH/ECCD	FWH/FWCD	Counter NBI
AT profile control			
Off-axis CD	✓		
Increase $\beta_e$	✓	✓	✓
$q_0, \hat{S}_m (\rho < 0.5)$		✓	✓
ITB			
$E \times B$			✓
Shafranov shift	✓		✓
Very high $f_{BS}$ (low CD)	✓	✓	✓
High $l_i$	✓	✓	
NTM stabilization	✓		
RWM and rotation	✓	✓	✓
Pedestal optimization	✓		✓
Electron transport	✓	✓	
Perturbative transport	✓		
Needed Resource	9 MW 10 Seconds	Fix Operate 6 MW System	Turn Around 1-2 Beamlines

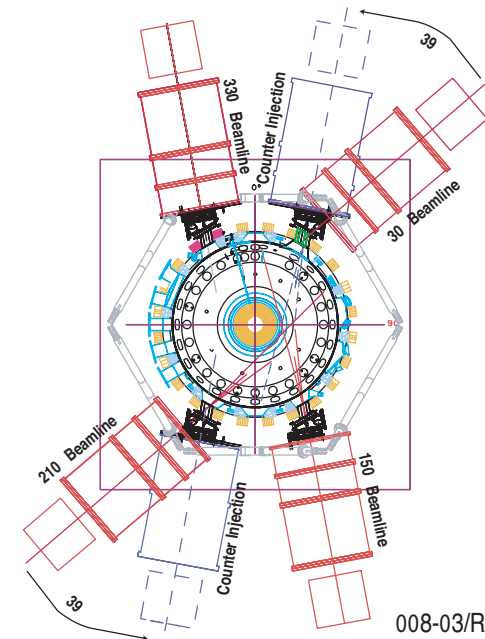

008-03/RDS/rs

# New Lower Hybrid Installation to enable Quasi-Steady Current Profile Control



- Five second flattop capability at 5 Tesla toroidal field
- With  $T_e = 5$  keV, corresponds to  $>5 \tau_{\text{skin}}$ ,  $\sim 2 \tau_{\text{L/R}}$ : **fully relaxed j-profile**
- Lower Hybrid current drive being implemented (March 2003 Installation)
- Time dependent LHCD modeling shows high bootstrap fully non-inductive AT regimes attainable

## Klystrons installed in C-Mod Test Cell



ACCOMME scenario: 70% bootstrap fraction

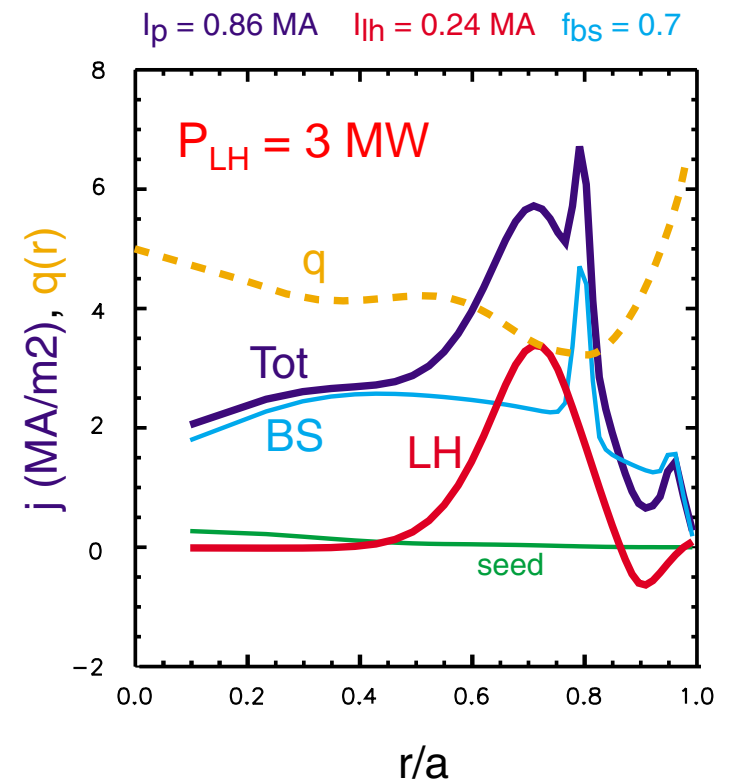

# SUMMARY OF DIII-D HARDWARE IMPROVEMENTS NEEDED FOR ADVANCED TOKAMAK RESEARCH PROGRAM

	MHD stability	Pressure and rotation profiles	Current profile	Comment / Other
I-Coil	RWM			Possible edge ergodization → pedestal
Long-pulse ECH/ECCD	NTM	Electron heating	Current drive	On- and off-axis
Fast wave reactivation		Electron heating	Current drive	On-axis
Divertor modification		Density profile		Particle inventory
Substation improvements	Allows full utilization of other tools	Allows full utilization of other tools	Allows full utilization of other tools	
Counter-NBI	Through rotation	Heating and torque	Co/counter NBCD	
10s pulse length improvements			Allows AT studies for >current redistribution time	
Edge ergodization	Edge stability	Pressure profile near edge		

# Urgent diagnostic and facility upgrades deferred for lack of resources and manpower



- 
- New Diagnostics and Upgrades include
    - Long pulse diagnostic neutral beam
      - Upgrades to associated MSE and CXRS systems
    - Electron-scale turbulence diagnostic(s)
    - Polarimetry
    - Reflectometry upgrade
    - Divertor IR imaging
    - SOL flow imaging
  - Facility Upgrades
    - Phase II of LHCD
    - Load tolerant real-time ICRF matching system
    - Data acquisition and computing
  - Including personnel, ~ \$2M/year for 5 years

# IN ADDITION TO BURNING PLASMA FUNDING, THE U.S. BASE PROGRAM NEEDS A 20% – 40% BUDGET INCREASE

---

- **Tokamak program needs are important component of that base program need**
  - We must continue to learn and develop the scientific basis for fusion energy
  - Some physics issues are better addressed in current machines
  - The advanced operating modes being developed will be the starting point for research in the BPX
  - The research and operating staff for the BPX will be trained on current devices
  - Overall need is roughly \$67 M/yr → \$90 M/yr
- **A diagnostic initiative is needed to increase plasma measurement capabilities throughout the Fusion Program**
  - \$10 M/yr
- **The time is ripe for a transport initiative to stimulate a great advance in fusion's largest remaining basic science question**
  - \$5–10 M/yr